

İLKOKUL

# TÜRKÇE

---

1

---

İşitme Engelli Öğrenciler İçin  
Okuma Yazma Öğreniyorum

**Etkinlik Kitabı**

I, II, III, IV, V. Ses Grupları



Ankara, 2020

**Genel Yayın Yönetmeni**

Mehmet Nezir GÖL

**Editörler**

Kürşat DULKADİR  
Prof. Dr. Mehmet KARA  
Prof. Dr. Aliye USLU ÖSTTEN

**Danışmanlar**

Prof. Dr. Ümit GİRGİN  
Doç Dr. Halise Pelin KARASU

**Program Geliştirme Uzmanı**

Bahar KÜÇÜKTEPE

**Hazırlayanlar**

Ahmet BEŞKAYA  
Aysel DOĞAN  
Ayşegül İŞLEKELLER BOZCA  
Ayşenur AKBAŞ  
Bedia KARAMETE  
Belgin SEVGI İÇYÜZ  
Emine ATLAY  
Emre GÜNDÜZ  
Hakan GÜNEY  
Halil ÇAM  
Kübra YURTTAŞ  
Levent KESKİN  
Mazhar ÜNAL  
Mehmet Akif CİHAN  
Mehmet Rasim TAŞ  
Mehmet SEZER ORDU

Mert ARIK  
Merve KOÇ  
Metin Gül  
Niyet DEMİRCİ  
Nursel SİBEL ŞENEL  
Ozan CAN CEYLAN  
Ömer Faruk AKMAN  
Seyhan KAPLAN  
Sultan KUŞ  
Şadi MUAZ KALENDER  
Uğur BOZKURT  
Uğur KERİMOĞLU  
Ümit KÖK  
Yusuf YILMAZ  
Zeynep ŞAHİN

**AFS MEDYA****Grafik Tasarım-Dizgi-Resimleme-Baskı**

21. Cad. 1424. Sk. No:8/2 Ostim O.S.B. Yenimahalle / ANKARA  
(0312) 472 96 66

**Millî Eğitim Bakanlığı Genel Dizgi Yayın No****ISBN**

Yayımlanan eserin hukuki sorumluluğu yazarlarına aittir.  
Millî Eğitim Bakanlığı'nın yazılı izni olmadan bu kitap içeriğinin bir kısmı  
veya tamamı yeniden üretilemez, çoğaltılamaz, dağıtılamaz.



## İSTİKLÂL MARŞI

Korkma, sönmez bu şafaklarda yüzen al sancak;  
Sönmeden yurdumun üstünde tüten en son ocak.  
O benim milletimin yıldızıdır, parlayacak;  
O benimdir, o benim milletimindir ancak.

Çatma, kurban olayım, çehreni ey nazlı hilâl!  
Kahraman ırkıma bir gül! Ne bu şiddet, bu celâl?  
Sana olmaz dökülen kanlarımız sonra helâl...  
Hakkıdır, Hakk'a tapan, milletimin istiklâl!

**Mehmet Âkif ERSOY**

## ANDIMIZ

Türküm, doğruyum, çalışkanım,  
İlkem; küçüklerimi korumak, büyüklerimi saymak, yurdumu,  
milletimi özümden çok sevmektir.

Ülküm; yükselmek, ileri gitmektir.

Ey büyük Atatürk! Açtığın yolda, gösterdiğin hedefe  
durmadan yürüyeceğime ant içerim.

Varlığım, Türk varlığına armağan olsun.

"Ne mutlu Türküm diyene!"

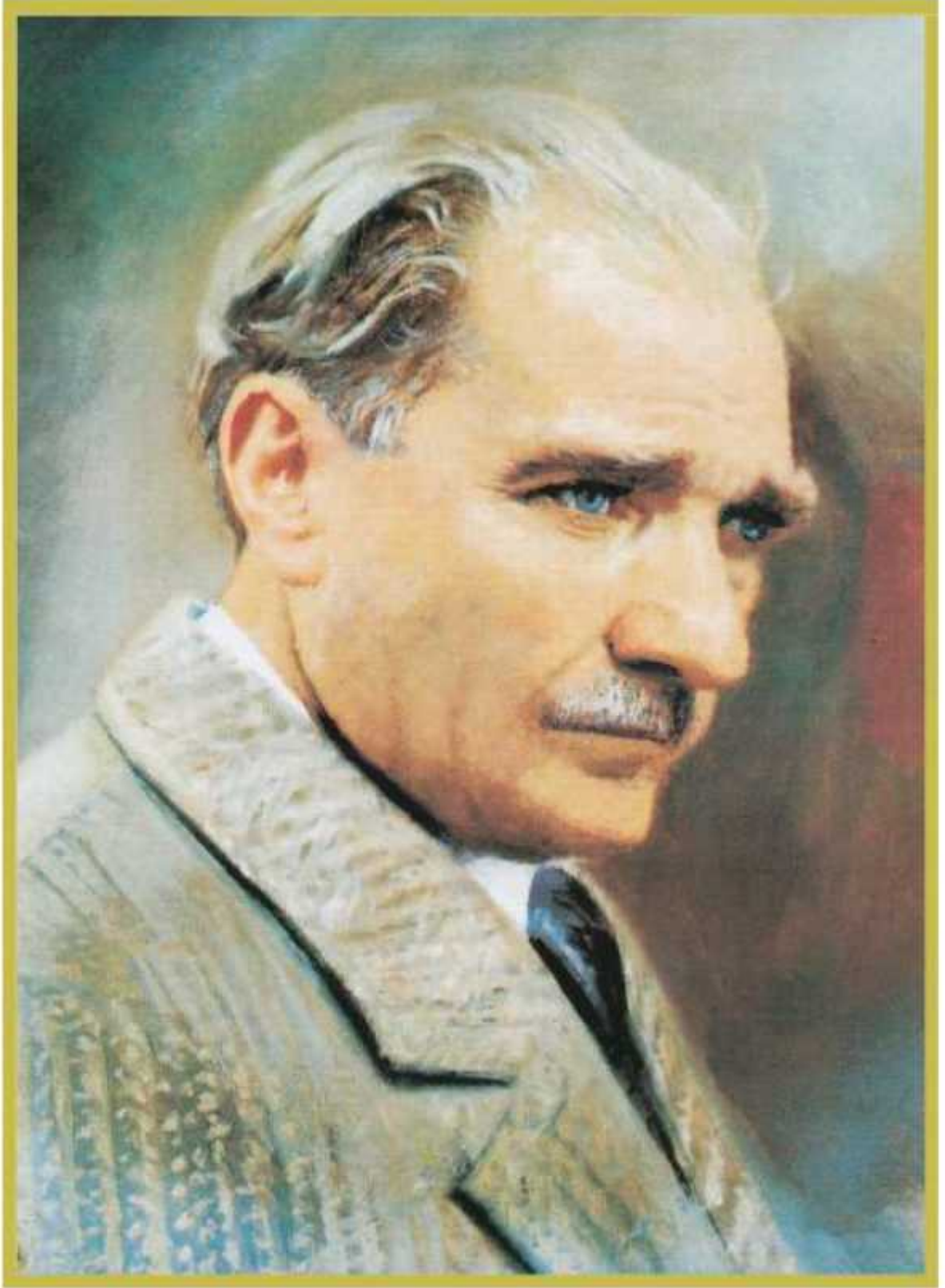

MUSTAFA KEMAL ATATÜRK

# İÇİNDEKİLER

## I. Ses Grubu (e, l, a, k, i, n,)

|                 |    |
|-----------------|----|
| E, e SESİ ..... | 8  |
| L, l SESİ ..... | 20 |
| A, a SESİ ..... | 27 |
| K, k SESİ.....  | 35 |
| İ, i SESİ ..... | 43 |
| N, n SESİ.....  | 50 |

## II. Ses Grubu (o, m, u, t, ü, y)

|                 |     |
|-----------------|-----|
| O, o SESİ.....  | 59  |
| M, m SESİ.....  | 68  |
| U, u SESİ ..... | 79  |
| T, t SESİ.....  | 86  |
| Ü, ü SESİ ..... | 94  |
| Y, y SESİ.....  | 103 |

## III. Ses Grubu (ö, r, l, d, s, b)

|                 |     |
|-----------------|-----|
| Ö, ö SESİ.....  | 114 |
| R, r SESİ ..... | 121 |
| l, l SESİ ..... | 132 |
| D, d SESİ.....  | 140 |
| S, s SESİ ..... | 146 |
| B, b SESİ.....  | 156 |

#### **IV. Ses Grubu (z, ç, g, ş, c, p)**

|                |     |
|----------------|-----|
| Z, z SESİ..... | 168 |
| Ç, ç SESİ..... | 176 |
| G, g SESİ..... | 184 |
| Ş, ş SESİ..... | 194 |
| C,c SESİ.....  | 203 |
| P, p SESİ..... | 215 |

#### **V. Ses Grubu (h, v, ğ, f, j)**

|                |     |
|----------------|-----|
| H, h SESİ..... | 224 |
| Y, y SESİ..... | 232 |
| Ğ, ğ SESİ..... | 240 |
| F, f SESİ..... | 249 |
| J, j SESİ..... | 258 |



Etkinlik E, e Sesi Yaz.

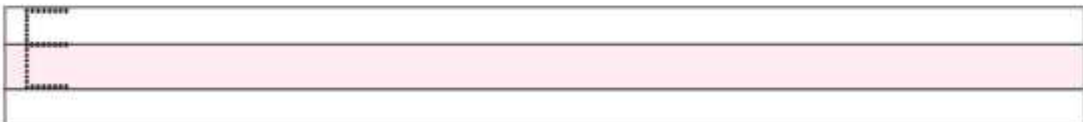
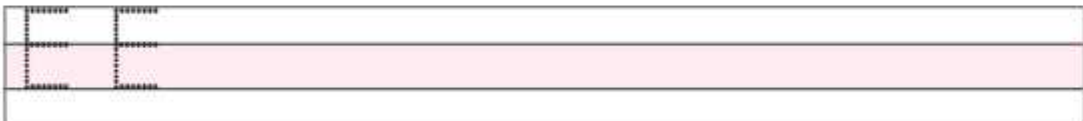



2.

Etkinlik E, e Sesi Yaz.



e e e e e e e e e e e e e e e e e

e e e e e e e e e

e e e e e e

e e e e

e e

e

3

Etkinlik E, e Sesi

"e" ile başlayan kelimeleri bul, boya.



ekmek



etek



masa



armut

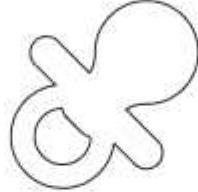

emzik



top



elma



balon



ev



eldiven

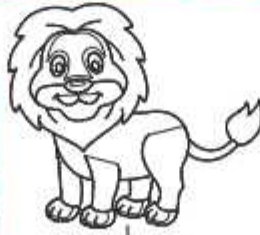

aslan



limon



Etkinlik E, e Sesi

"E" ve "e" sesini bul, işaretle.

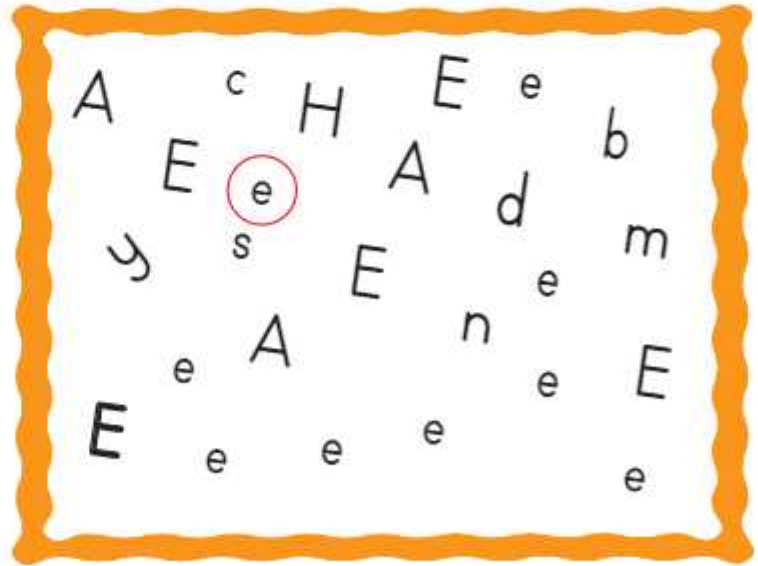
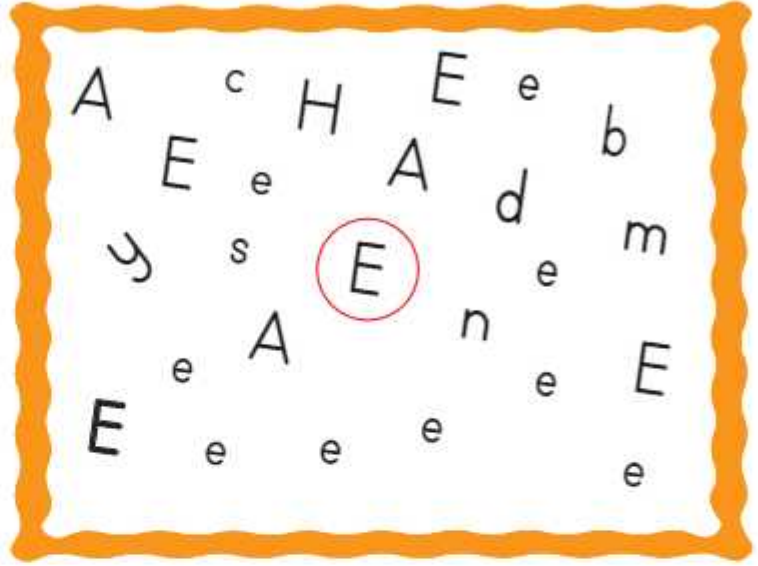
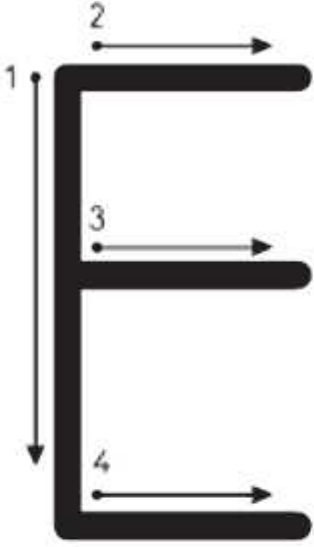

5.

Etkinlik E, e Sesi

"E, e" sesini bul, boya ve elma ağacına git.

Ee



|   |   |   |   |   |   |   |   |   |   |   |   |   |   |   |
|---|---|---|---|---|---|---|---|---|---|---|---|---|---|---|
| ç | a | l | i | e | E | e | E | e | E | e | s | Ü | e | T |
| G | B | g | Ç | U | n | Ş | Ü | O | p | E | v | N | b | O |
| a | Z | e | E | e | E | e | E | e | E | e | h | H | G | ğ |
| Ö | u | E | s | d | R | r | N | m | K | L | P | E | ğ | Ü |
| E | ö | e | O | K | E | E | e | E | e | Ü | i | e | s | Ş |
| e | f | E | l | r | A | a | L | P | m | İ | S | E | e | T |
| E | b | e | E | e | E | e | E | e | E | e | N | ü | Ş | i |
| e | n | s | Ş | r | T | i | Ö | i | L | E | s | Y | y | v |
| E | e | E | H | e | E | e | E | e | E | e | ç | E | e | O |
| L | f | ü | u | E | Ğ | n | A | ş | L | g | s | C | e | E |
| p | Ö | Ş | k | e | E | e | E | e | E | D | s | e | E | e |



6.

Etkinlik E, e Sesi

Oku.

Lale elek eliyor, eli yere deęiyor.  
Elek elek eleme, bebeęimi beleme.  
Eller elek elesin, bebeęini belesin.



Etkinlik E, e Sesi Bak, anlat.

1. Ela evden çıkıyor.



7.

Etkinlik E, e Sesi Bak, anlat.

2. Evin bahçesinde elma ağacı var.



7.

Etkinlik E, e Sesi Bak, anlat.

3. Ela, elma ağacına bakıyor.

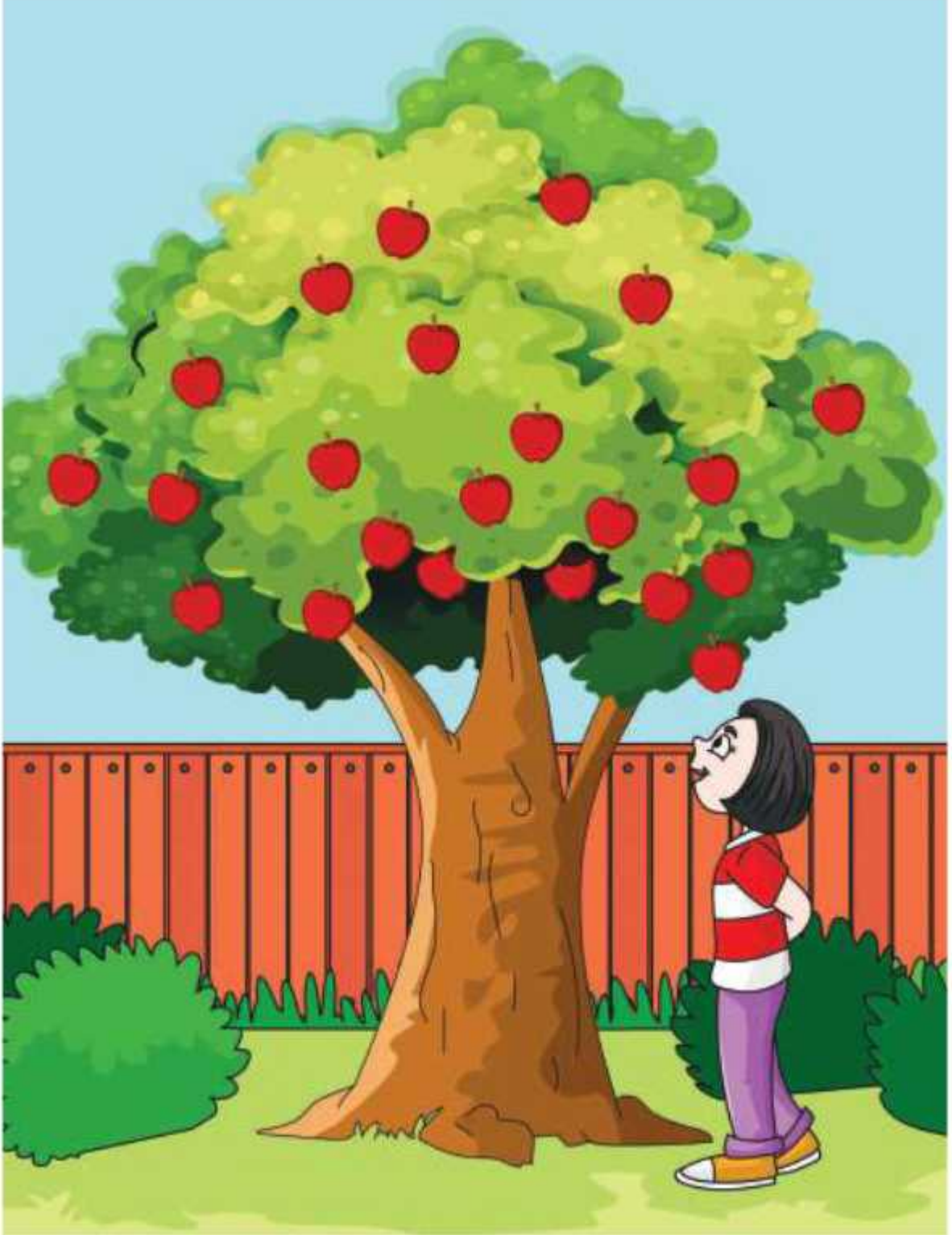



Etkinlik E, e Sesi Bak, anlat.

4. Annesi Ela'nın yanına geliyor.

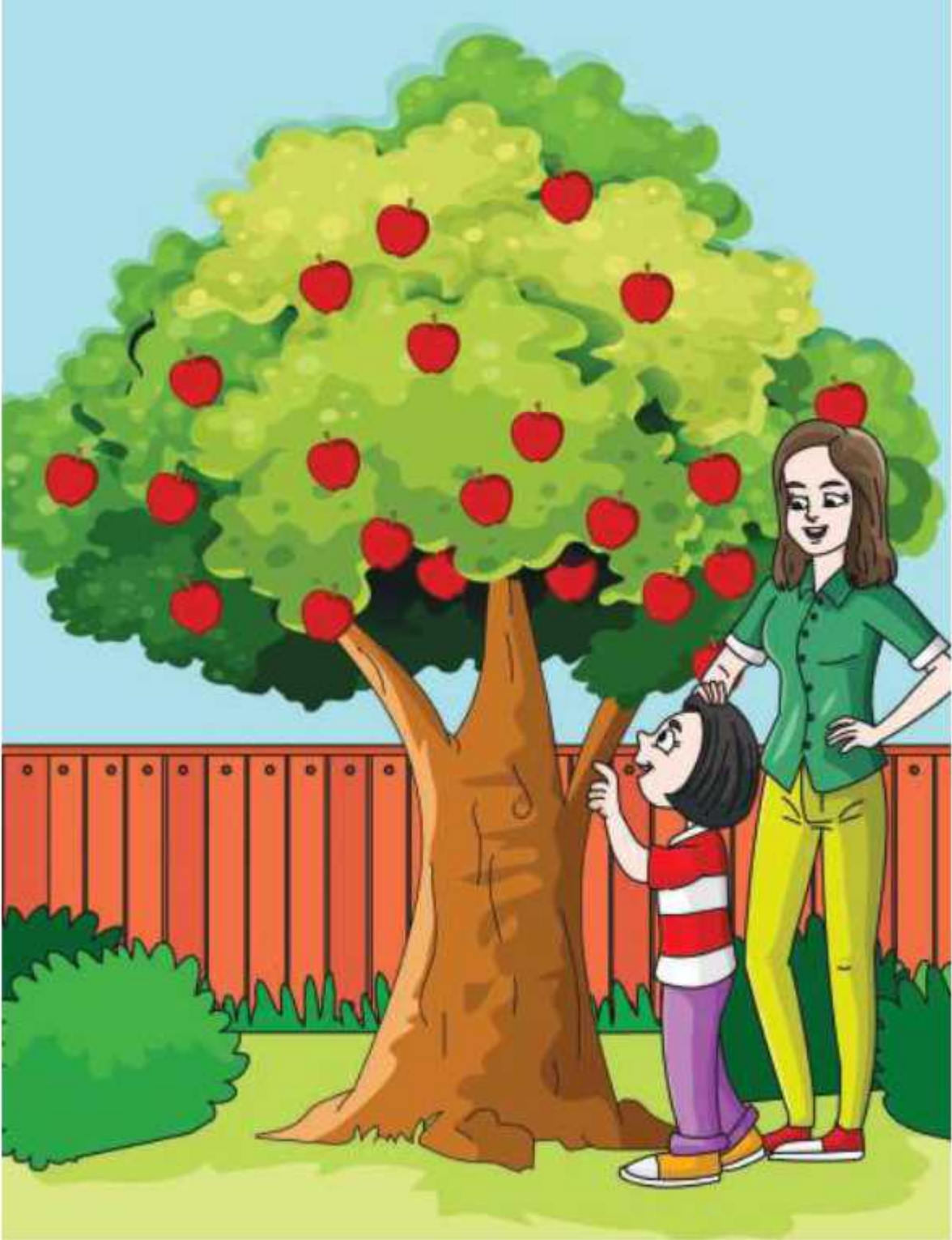





Etkinlik E, e Sesi Bak, anlat.

5. Beraber elma topluyorlar.

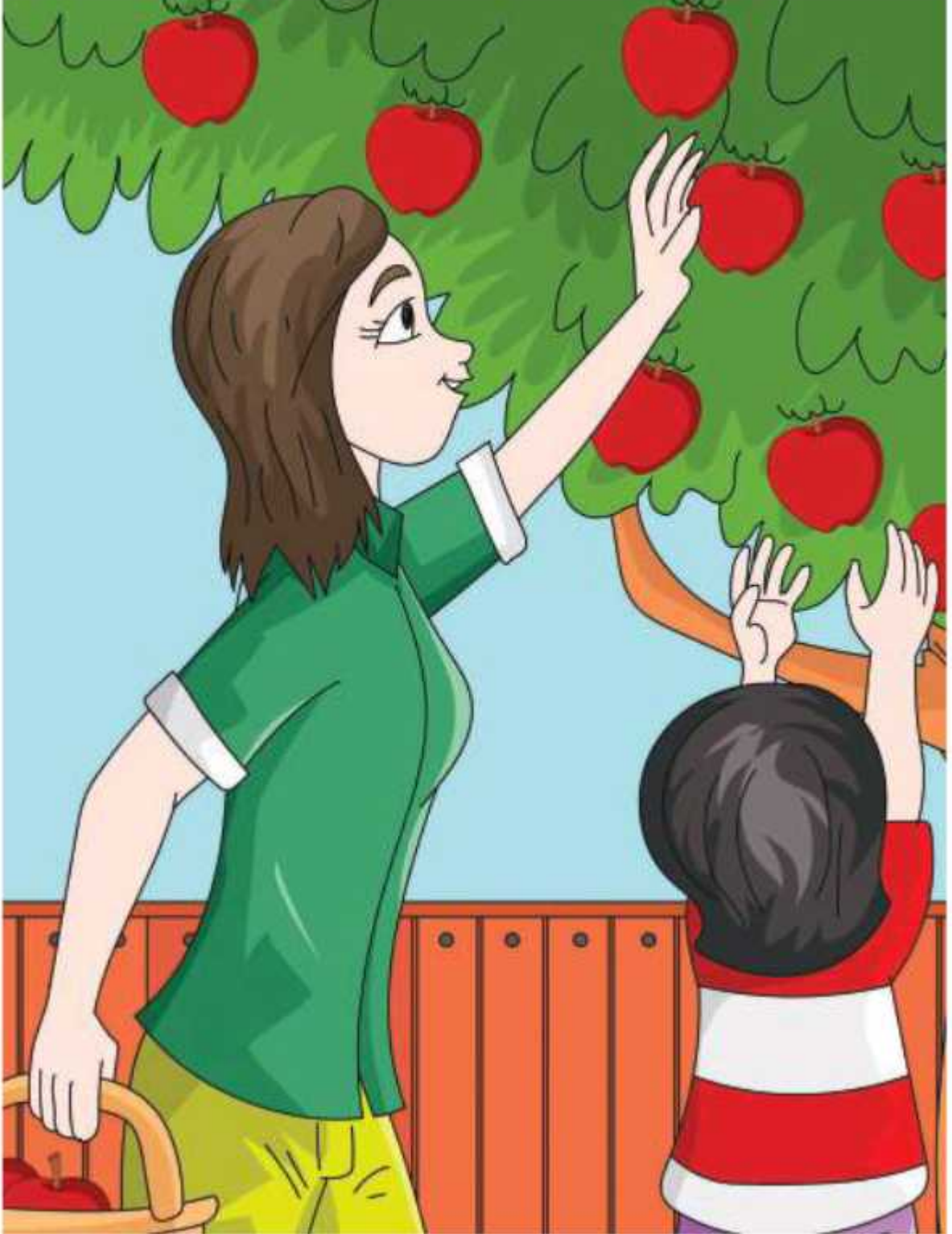

# 7.

Etkinlik E, e Sesi Bak, anlat.

6. El ele tutuřuyorlar. Eve gidiyorlar.





Etkinlik E, e Sesi

Labirenti takip et.  
Ela'yı evine ulaştır.

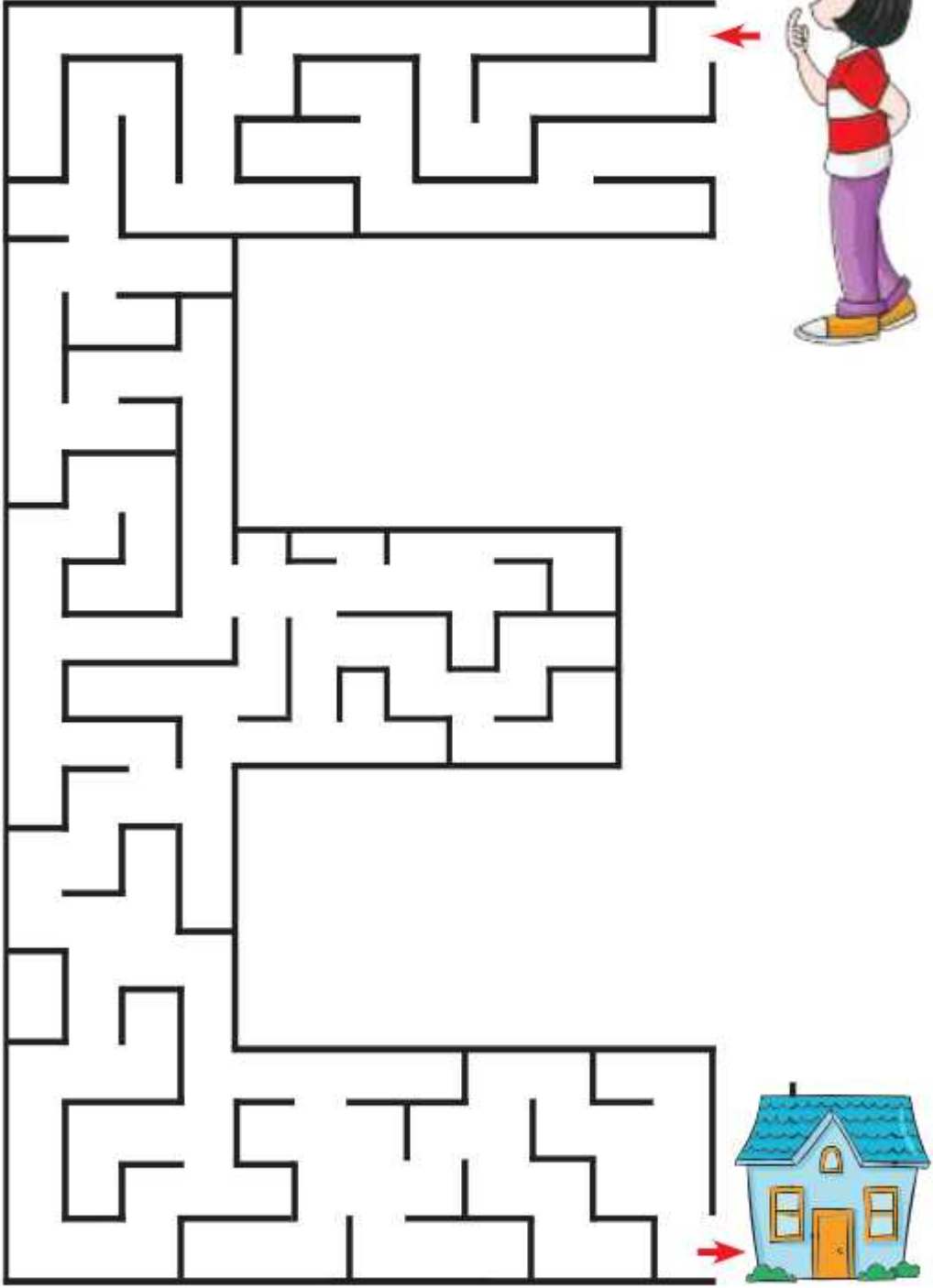



2.

Etkinlik L, l Sesi Yaz.



Handwriting practice lines for the letter 'l'. Each line consists of three horizontal bands: a top white band, a middle pink band, and a bottom white band. The first six lines contain dotted lowercase 'l' characters for tracing, with the number of characters decreasing from 12 in the first line to 1 in the sixth line. The remaining three lines are blank for independent practice.

3

Etkinlik L, l Sesi

"L" ile başlayanları bul, işaretle.





Etkinlik L, l Sesi

"L" ile başlayanları bul, işaretle.

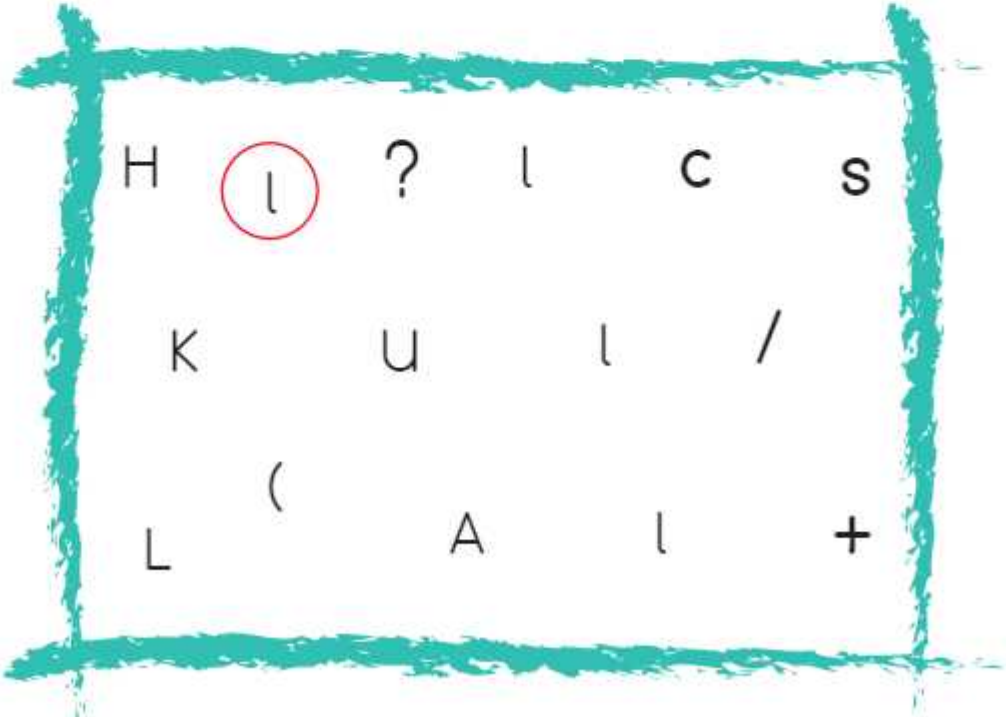
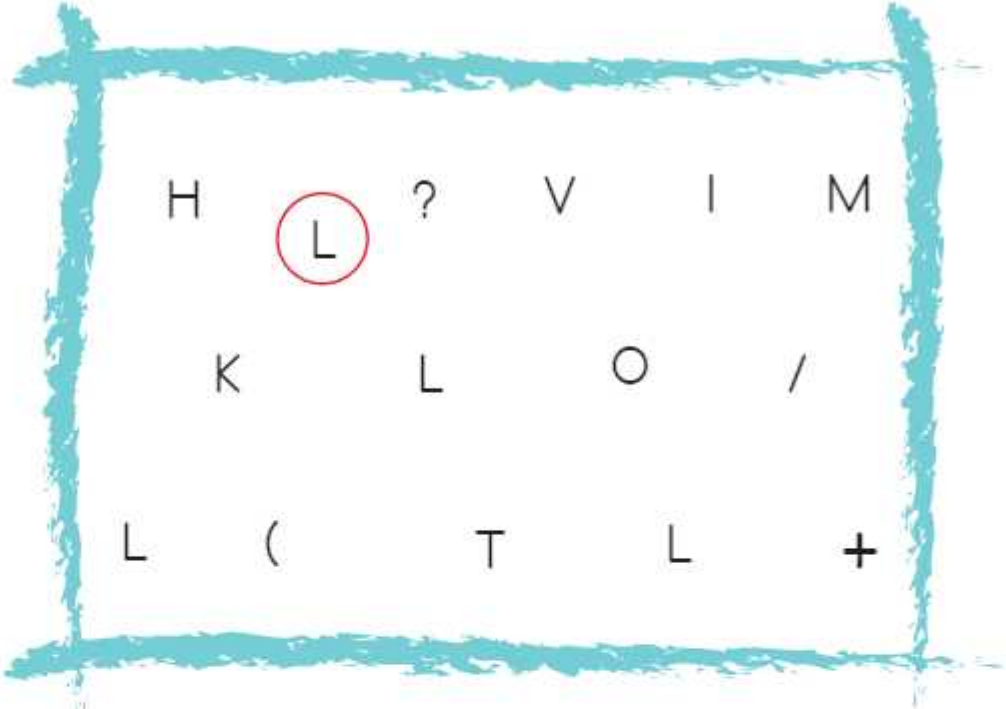

5.

Etkinlik L, l Sesi Çiz, boya.

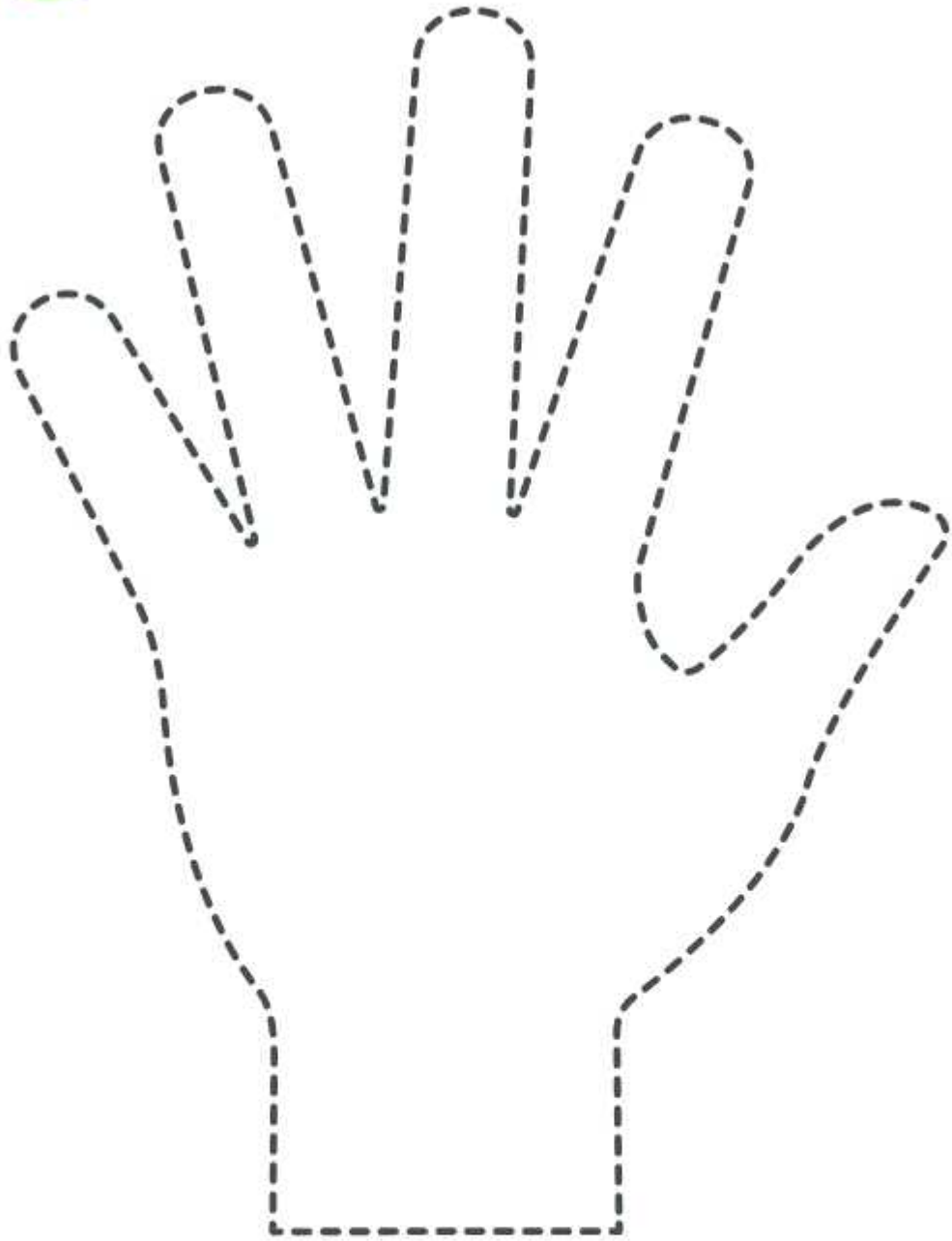

Yaz.

|  |
|--|
|  |
|  |
|  |

|  |
|--|
|  |
|  |
|  |





el

EL

ELE

ele

elle

ELLE

EL ELE

el ele



Etkinlik L, l Sesi Boya.

E ●

L ●

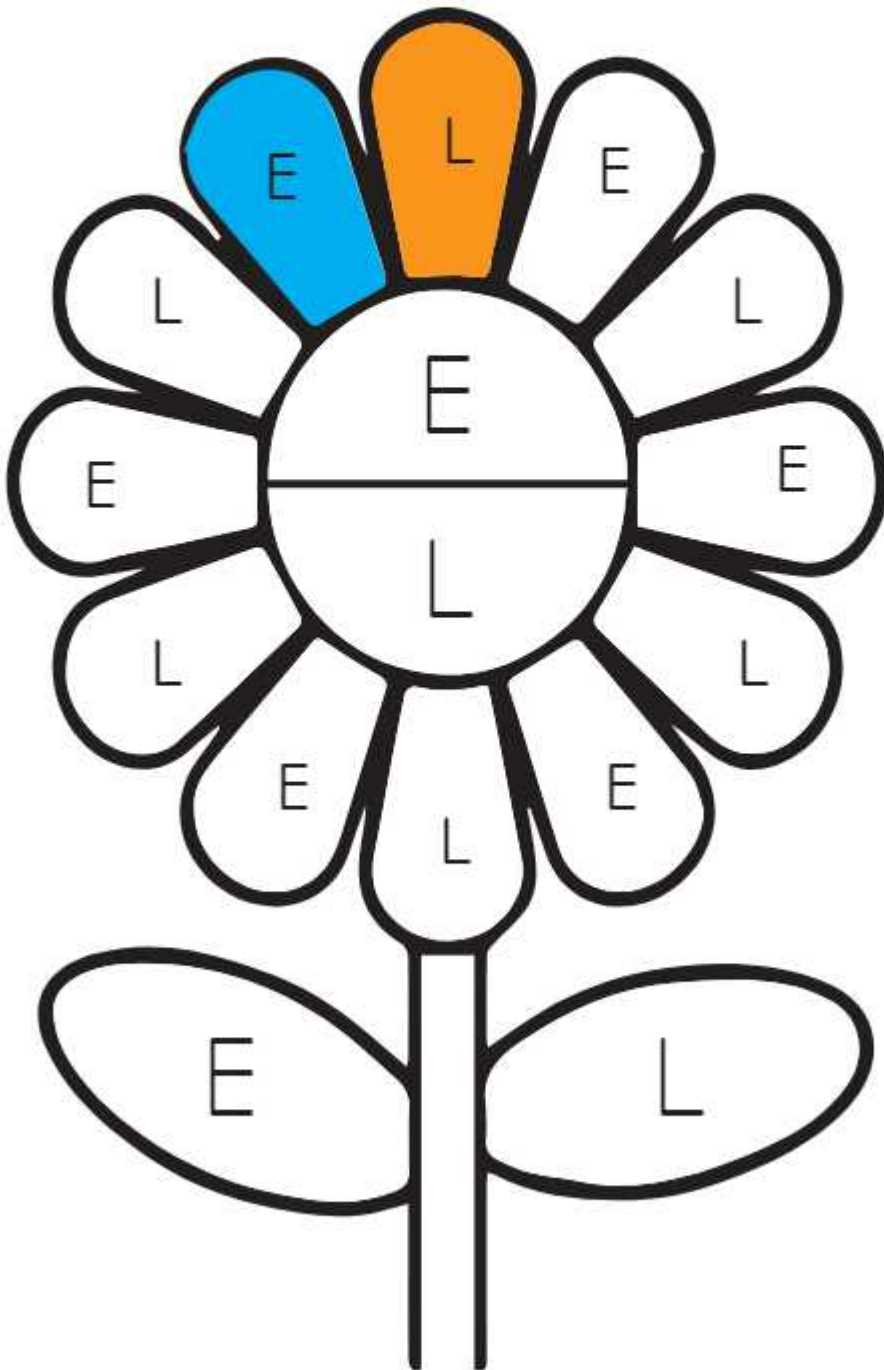



Etkinlik A, a Sesi Yaz.



A A A A A A A A A A A

A A A A A A

A A A A A

A A A

A A

A



Etkinlik A, a Sesi Yaz.

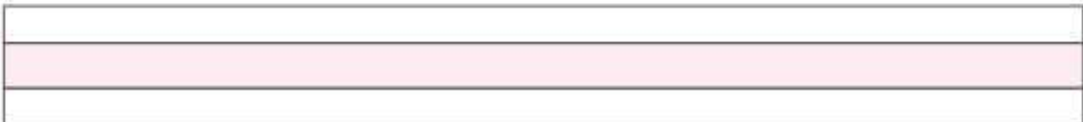
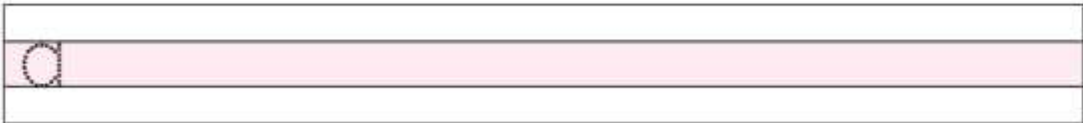
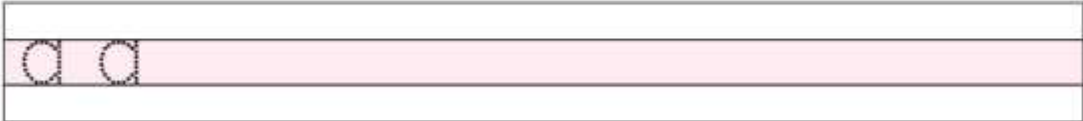
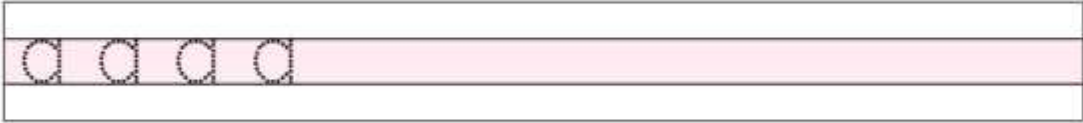
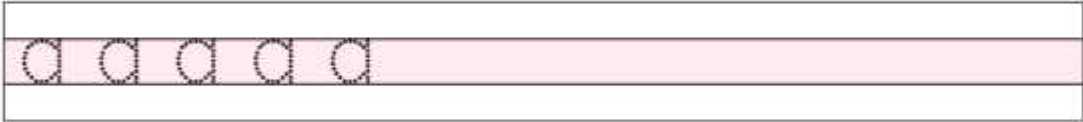
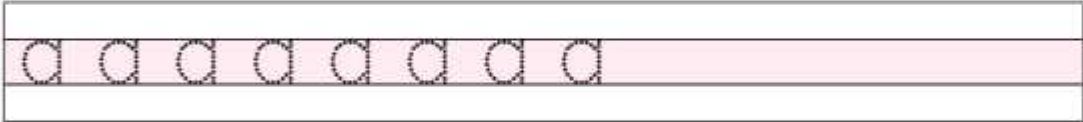
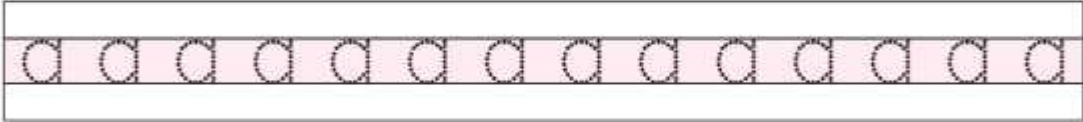



Etkinlik A, a Sesi

Adında "a" sesi olanı bul, boya.



4

Etkinlik A, a Sesi

Hangisinde "a" var?  
Çiz, boya.

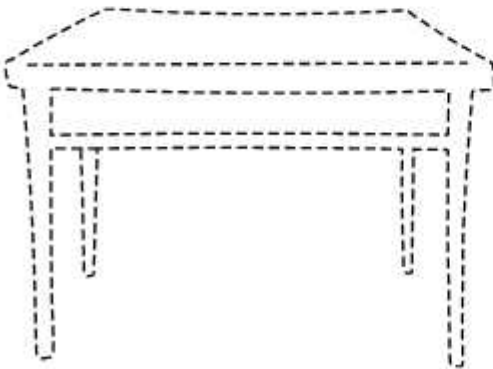
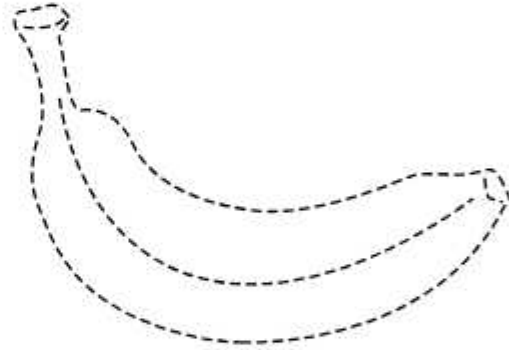
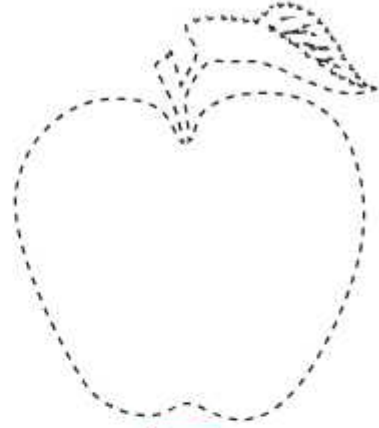
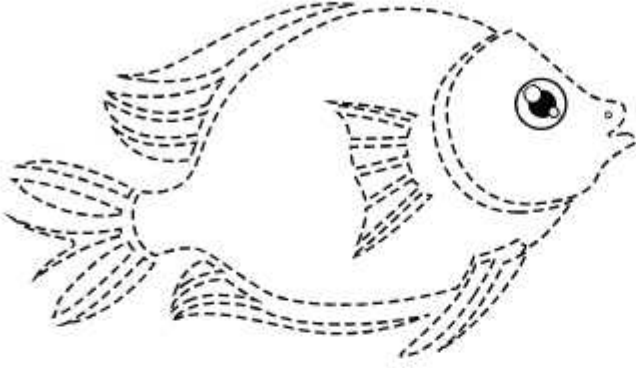



Etkinlik A, a Sesi "A a" sesini boya.

Aa

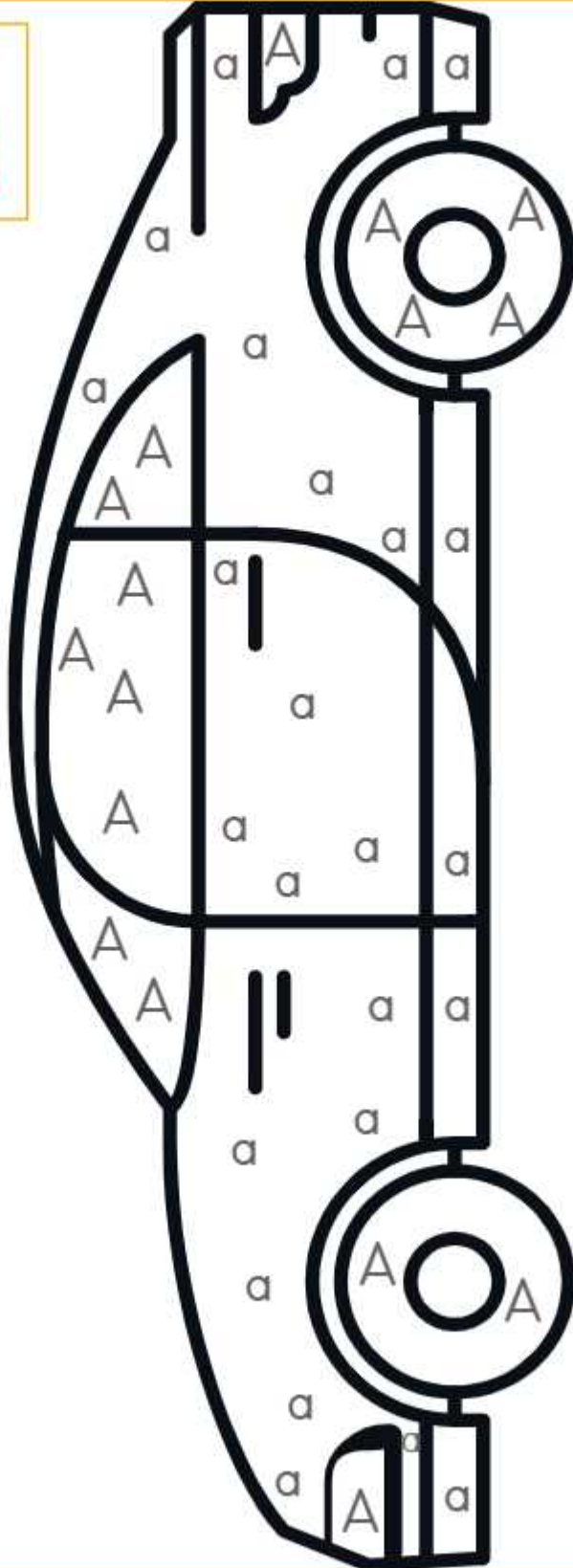



Etkinlik

A, a Sesi

Oku, birleştir, yaz.

a l

al

Blank writing lines for the first activity.

l a

Blank box for the second activity.

Blank writing lines for the second activity.

e la

Blank box for the third activity.

Blank writing lines for the third activity.

la le

Blank box for the fourth activity.

Blank writing lines for the fourth activity.





Etkinlik A, a Sesi

Kelimelerle  
görselleri eşle.

ela

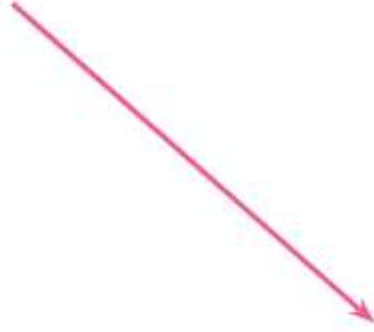

Ela



lale



Lale





Etkinlik A, a Sesi

Görsellerle  
cümleleri eşle.



Ela  al.



Ela, Lale el ele.



Ela lale al.



Ela lale elle.



Etkinlik K, k Sesi Yaz.

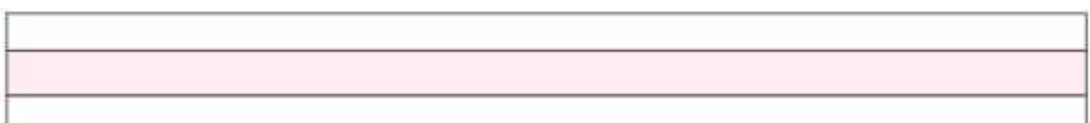
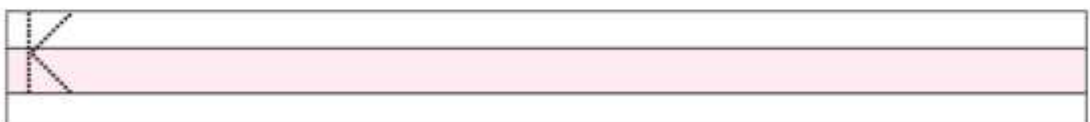
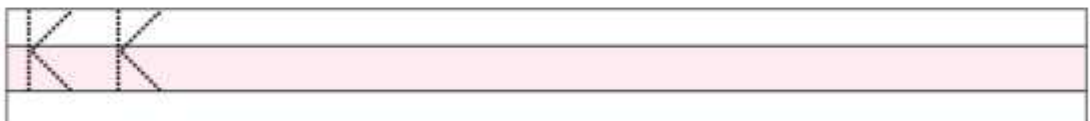
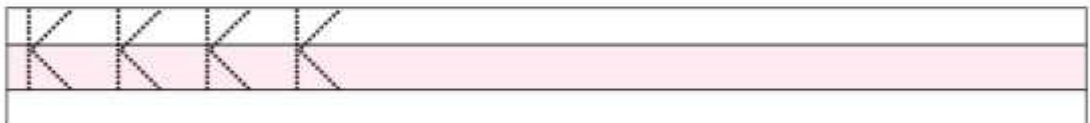
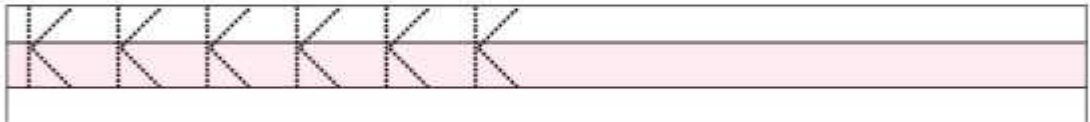
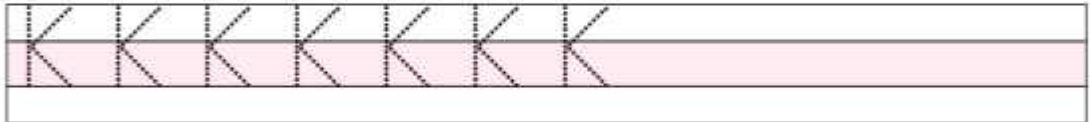
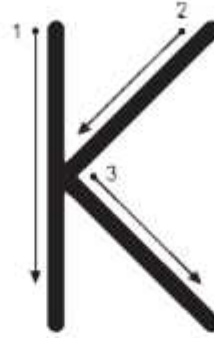

# 2.

## Etkinlik K, k Sesi Yaz.

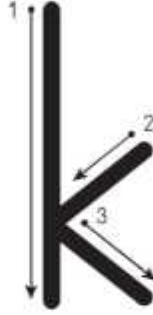

K K K K K K K K K K K K K K K K

K K K K K K K K K

K K K K K K

K K K K

K K

K



Etkinlik K k Sesi

"K" sesli kelimeleri  
bul, boya.

|   |   |   |
|---|---|---|
| kalem<br>        | araba<br>  | çadır<br>   |
| davul<br>       | esek<br>  | balık<br>  |
| kiraz<br>      | saat<br> | kedi<br> |
| televizyon<br> | kale<br> | masa<br> |



Etkinlik K, k Sesi

Köpeği kemiğe ulaştır.

K k



|   |   |   |   |   |   |   |   |   |   |   |   |   |   |   |
|---|---|---|---|---|---|---|---|---|---|---|---|---|---|---|
| a | s | A | B | k | K | k | M | i | Z | k | K | k | K | k |
| ü | Ç | l | c | K | d | K | k | K | K | k | z | H | K | ğ |
| a | E | d | F | k | s | C | ç | k | f | F | E | e | E | o |
| O | ö | Y | i | K | D | f | g | G | F | k | L | m | E | t |
| ç | a | l | i | k | K | k | K | k | K | k | s | Ü | e | T |
| G | B | g | Ç | U | n | Ş | Ü | O | p | K | v | N | b | O |
| a | Z | k | K | k | K | k | K | k | K | k | h | H | G | ğ |
| Ö | u | K | s | d | R | r | N | m | K | L | P | E | ğ | Ü |
| E | ö | k | O | K | k | E | e | E | e | Ü | i | e | s | Ş |
| e | f | K | l | r | A | a | L | P | m | İ | S | E | e | T |
| E | b | k | K | k | K | k | K | k | K | k | N | ü | Ş | i |
| E | e | E | H | e | E | e | E | A | K | k | ç | E | e | O |
| L | f | ü | u | E | Ğ | n | A | ş |   | g | s | C | e | E |
| p | Ö | Ş | k | e | B | e | k | e |   | D | s | e | E | e |





Etkinlik K, k Sesi

Oku, yaz.

|       |       |      |      |
|-------|-------|------|------|
| ek    | ak    | ke   | ka   |
| kel   | kal   | kek  | lak  |
| lek   | leke  | kale | elek |
| leke  | kala  | akla | ekle |
| aka   | eke   | keke | kele |
| alaka | kelek | kalk | kale |

|  |
|--|
|  |
|  |
|  |

|  |
|--|
|  |
|  |
|  |

|  |
|--|
|  |
|  |
|  |

|  |
|--|
|  |
|  |
|  |

|  |
|--|
|  |
|  |
|  |

# 6.

## Etkinlik K, k Sesi

Cümle ile resmi eşle, yaz.



Ela kek al.

Ela kek al.



Lale elek al.

|  |
|--|
|  |
|  |
|  |



Ela lale al.

|  |
|--|
|  |
|  |
|  |



Lale kalk, elek al.

|  |
|--|
|  |
|  |
|  |



Ela, Lale el ele kek al.

|  |
|--|
|  |
|  |
|  |





Etkinlik K, k Sesi

Bak, yaz.



kek





## Etkinlik K, k Sesi

Bulmacayı çöz.

ela, lale, al, kale, kel, elek, kelek, alaka, kek,  
leke, kalk, kal, ak, el, lake, ek

|   |   |   |   |   |   |   |   |   |   |
|---|---|---|---|---|---|---|---|---|---|
| l | e | k | e | z | n | f | h | m | a |
| i | k | t | e | l | a | v | k | l | e |
| k | a | l | k | e | k | s | t | c | l |
| t | u | a | ü | e | j | m | c | k | e |
| i | z | l | a | l | e | k | a | l | k |
| e | i | e | e | h | l | a | k | e | f |
| k | a | l | e | k | e | l | e | k | a |
| e | i | b | n | z | v | l | z | e | l |
| a | l | a | k | a | m | m | k | e | l |
| s | e | k | e | l | e | k | g | y | h |



Etkinlik İ, i Sesi Yaz.



Handwriting practice lines for the letter 'i'. Each row consists of a top line, a middle line, and a bottom line. The area between the middle and bottom lines is shaded pink. The first row has vertical dashed lines for tracing. The second row has vertical dashed lines for tracing. The third row has vertical dashed lines for tracing. The fourth row has vertical dashed lines for tracing. The fifth row has vertical dashed lines for tracing. The sixth row has vertical dashed lines for tracing. The seventh row has vertical dashed lines for tracing. The eighth row has vertical dashed lines for tracing. The ninth row has vertical dashed lines for tracing. The tenth row has vertical dashed lines for tracing.



Etkinlik

İ, i Sesi

Yaz.



Tracing practice row 1: A row of 20 dotted vertical lines on a pink background, each with a small 'i' above it.

Tracing practice row 2: A row of 15 dotted vertical lines on a pink background, each with a small 'i' above it.

Tracing practice row 3: A row of 10 dotted vertical lines on a pink background, each with a small 'i' above it.

Tracing practice row 4: A row of 7 dotted vertical lines on a pink background, each with a small 'i' above it.

Tracing practice row 5: A row of 3 dotted vertical lines on a pink background, each with a small 'i' above it.

Tracing practice row 6: A row of 1 dotted vertical line on a pink background, with a small 'i' above it.

Blank writing row 7: A row with a pink background for writing.

Blank writing row 8: A row with a pink background for writing.

# 3

## Etkinlik

## İ, i Sesi

“i” ile başlayanları bul, işaretle.



ip



tarak



makas



civciv



inek



balık



iğne



kalem



çanta







Etkinlik

İ, i Sesi

Kes, yapıştır.

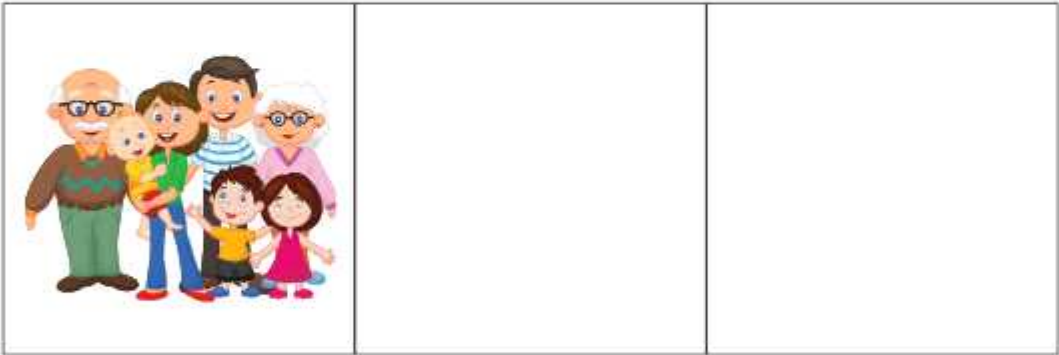
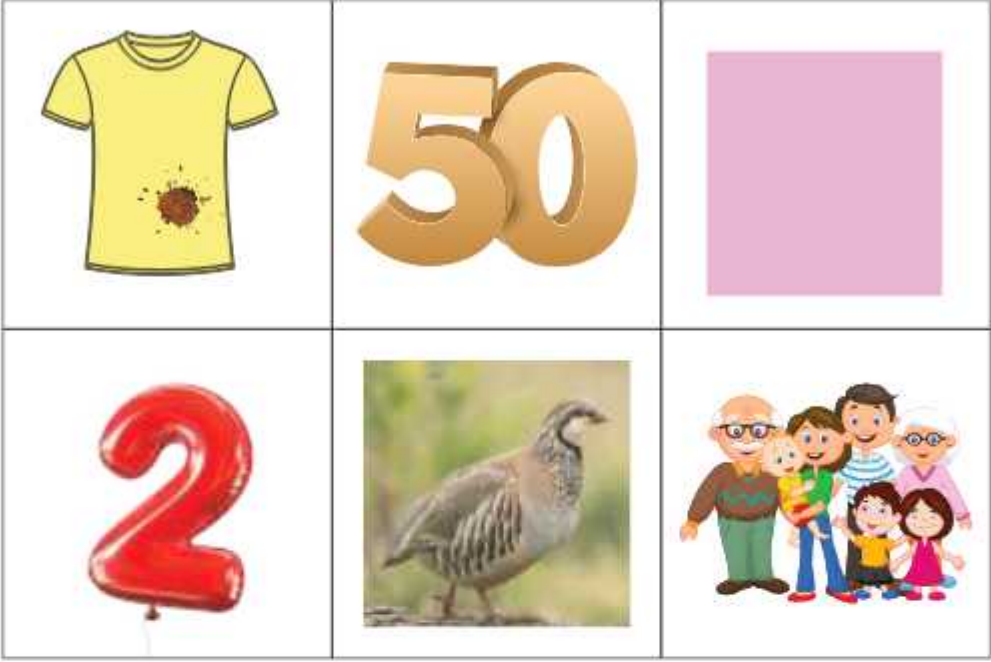

aile

elli

keklik

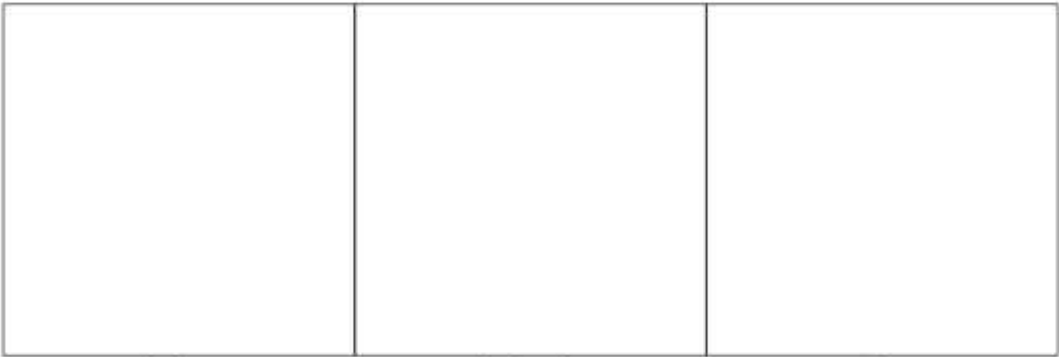

lila

lekeli

iki

## 5. Etkinlik İ, i Sesi





Etkinlik İ, i Sesi

Eksik resimleri bul, örnekteki gibi yaz.

|  |  |  |  |
|--|--|--|--|
|  |  |  |  |
|  |  |  |  |
|  |  |  |  |
|  |  |  |  |

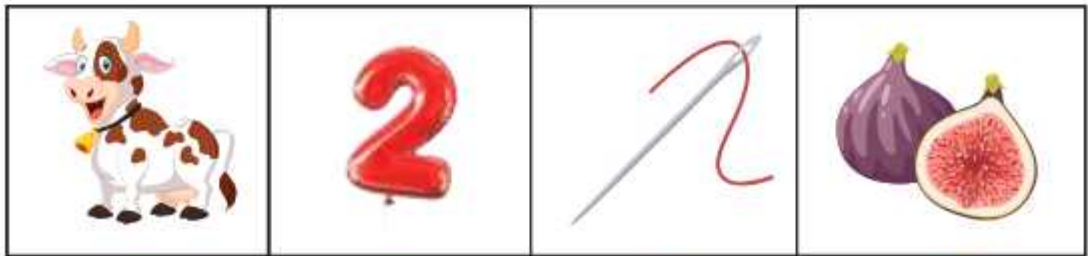

1

2

3

4



Etkinlik N, n Sesi Yaz.

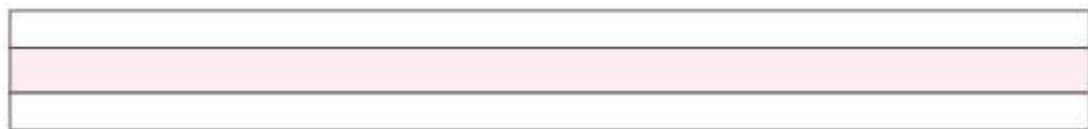
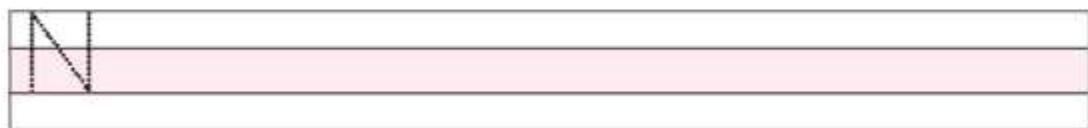
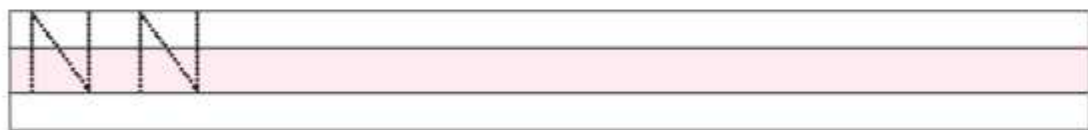
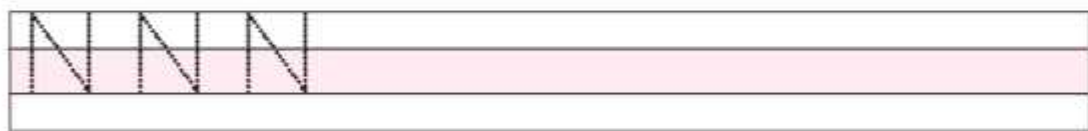
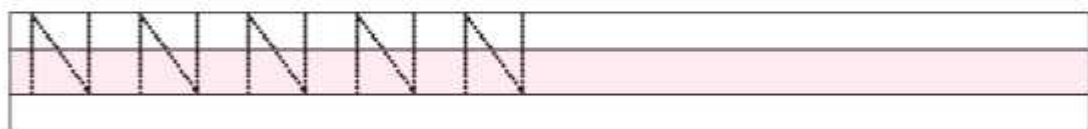
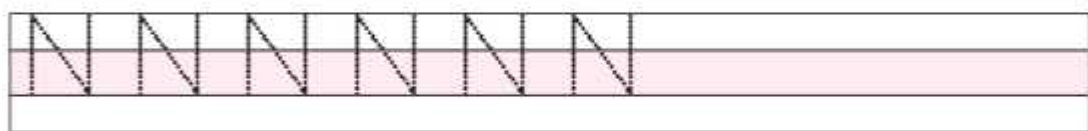
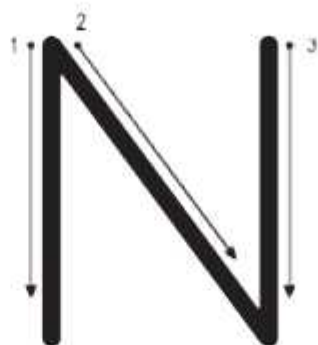



Etkinlik N, n Sesi Yaz.



Handwriting practice lines for the letter 'n'. Each line consists of a top line, a middle line, and a bottom line. The first seven lines contain a series of 'n' characters that decrease in size from left to right, with the first line being the largest and the seventh line being the smallest. The remaining three lines are empty for independent practice.



Etkinlik N, n Sesi

Adında "n" sesi  
olanı bul, boya.

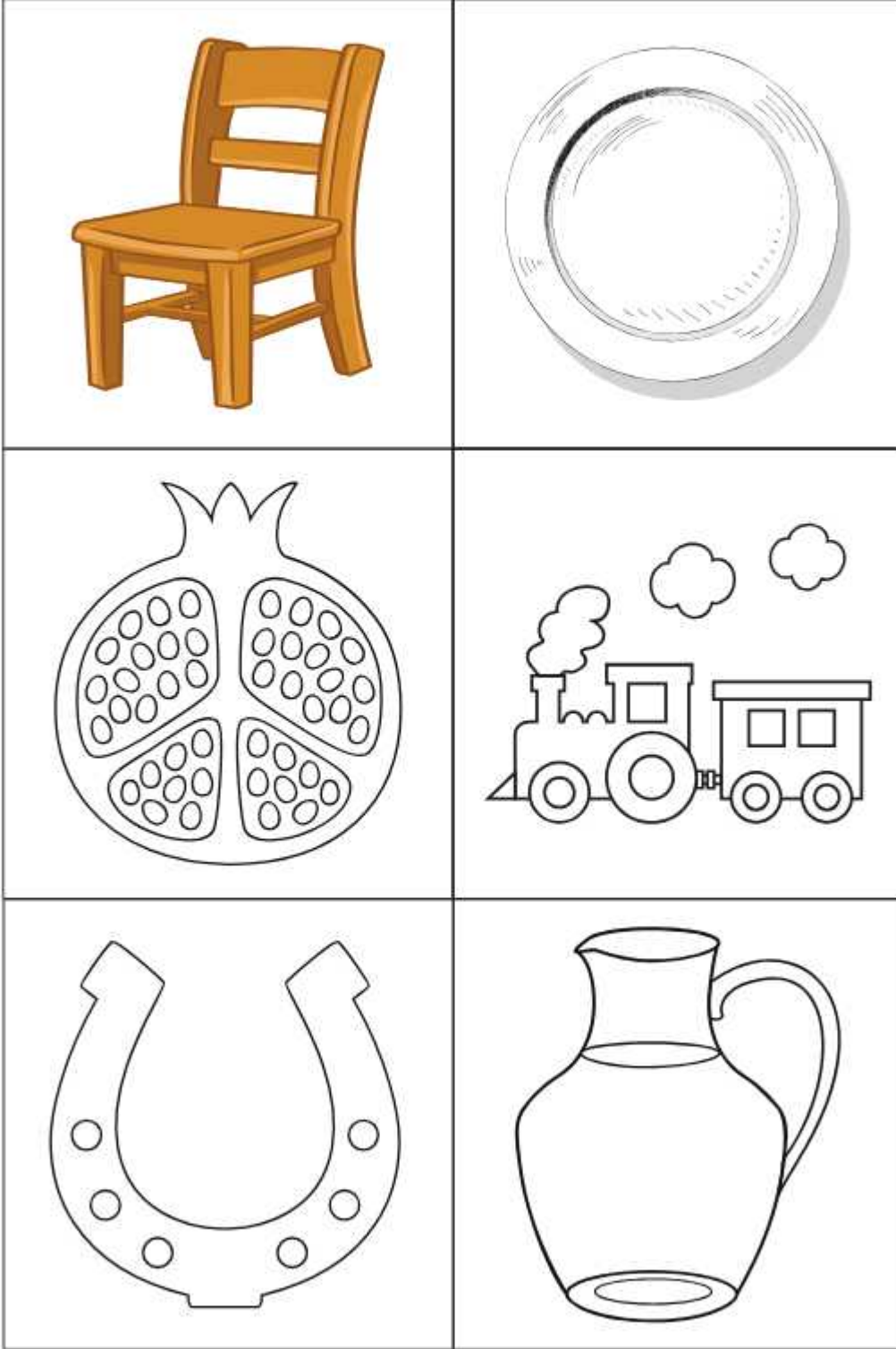

## 4

## Etkinlik N, n Sesi İşaretle.

"n" sesi başta ise ●, "n" sonda ise ♥,

"n" ortada ise ★

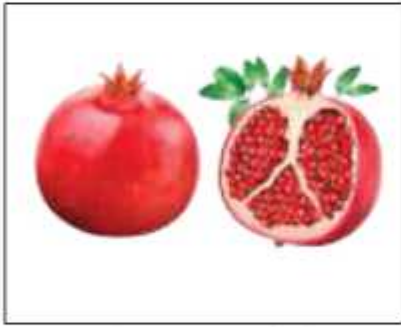

5.

Etkinlik N, n Sesi "N, n" sesini boya.





Etkinlik) N, n Sesi Oku, yaz.

nine

nane

inek



nine

kene

anne

Nail



enti

anta

ninni





Etkinlik N, n Sesi

Boşluklara "n" sesini yaz, oku.

n

nit

a \_ \_ e

\_ at

\_ ar

n

nine

\_ ata \_

e \_ li

a \_ la





Etkinlik N, n Sesi 5 defa oku.

AL

Nane al.

Nalan nane al.

Nalan üç nane al.

Nine, Nalan'a üç nane al.

Nalan üç nane al.

Nalan nane al.

Nane al.

Al.



### İNEK

Nil inek al.

Ninene inek al.

Ak inek al.

Annene inek al.

İki inek al.

Nalan ile al.

Nine, Nil'e inek al.



9.

Etkinlik N, n Sesi Bak, anlat.





Etkinlik O, o Sesi Yaz.

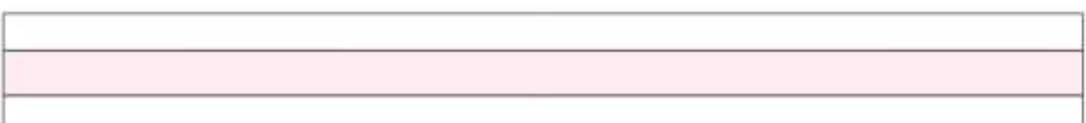
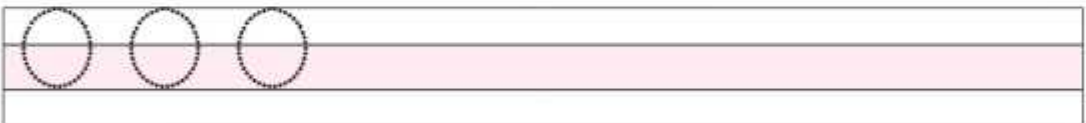
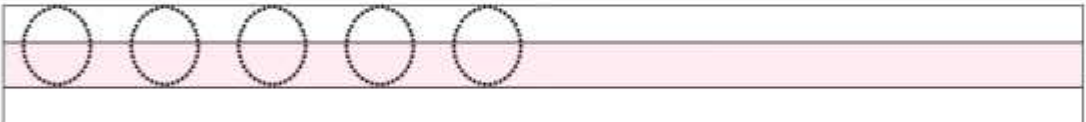
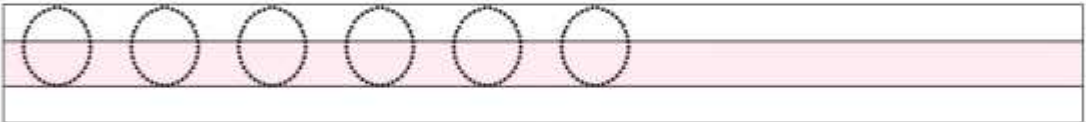
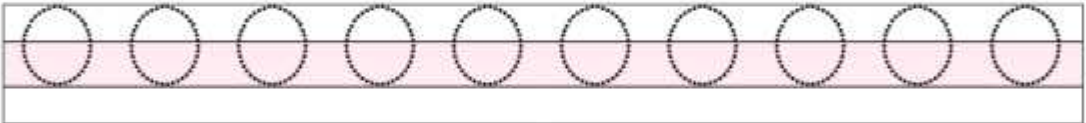



# 3

## Etkinlik O, o Sesi Bul, boya.



ok



kol



on



konak



alo



koni



Okan



kokla



kilo

|   |   |   |   |   |   |   |
|---|---|---|---|---|---|---|
| E | A | U | M | K | L | K |
| A | L | K | M | O | İ | O |
| K | O | L | İ | N | M | N |
| E | A | O | N | A | O | İ |
| K | O | L | K | K | K | K |
| M | K | O | K | L | A | O |
| O | K | A | İ | M | N | L |
| K | İ | L | O | K | N | İ |



koli

## 4

Etkinlik O, o Sesi Bul, yaz.



o, l, i, k

koli



o, l, k, i



o, k



l, o, k



u, o, k, l



u, m, o, l, k



O, n, k, a



a, l, e, l

5.

Etkinlik O, o Sesi Küp yap, anlat.

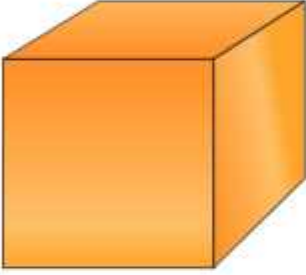

## 5. Etkinlik O, o Sesi



6.

Etkinlik O, o Sesi Bul, yaz.

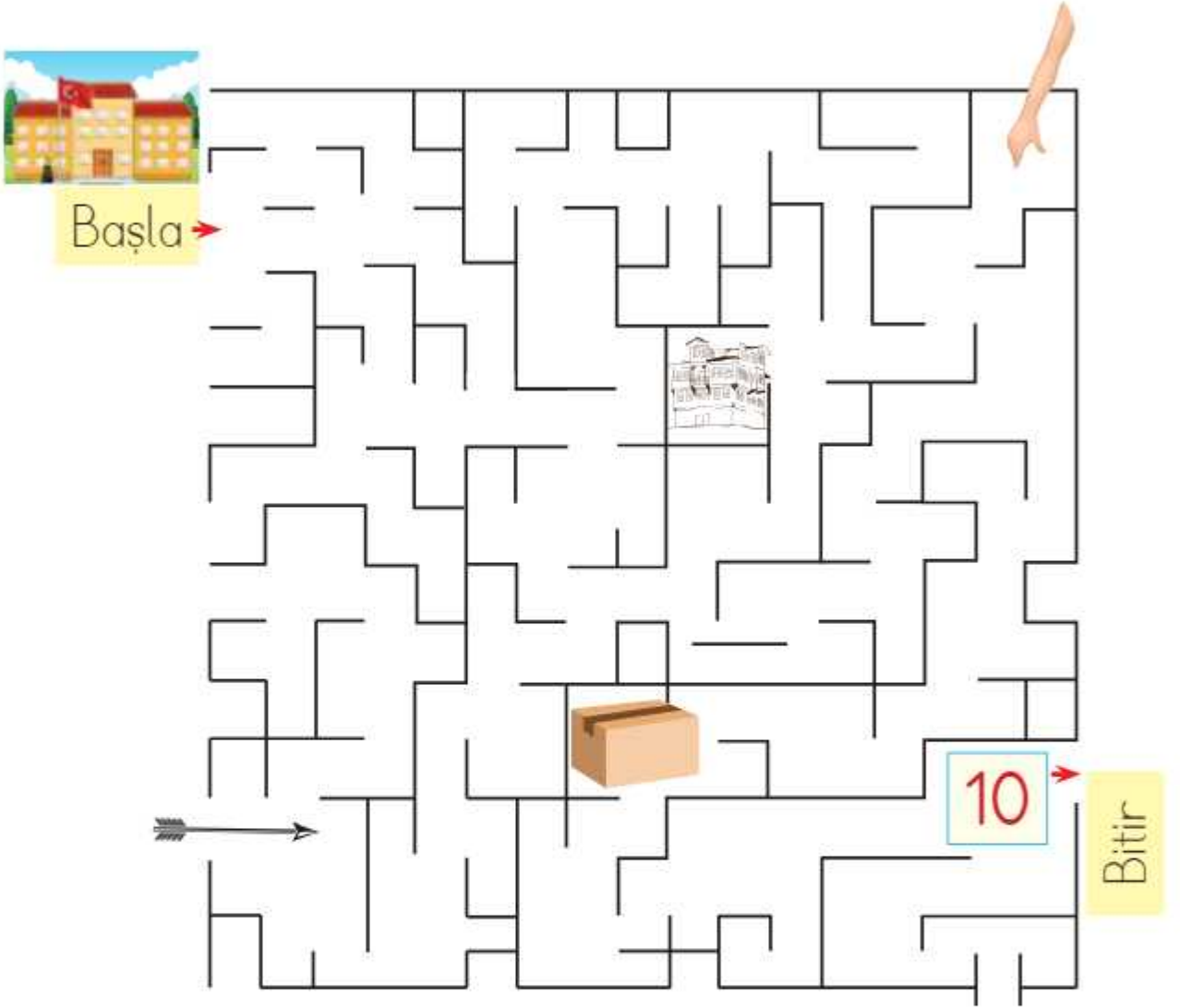

ok

7.

Etkinlik O, o Sesi Bul, yaz.

Perfume bottles (vertical)

Cardboard box (horizontal)

Boy holding a red flower (vertical)

House (horizontal)

Cone (vertical)

Hand (vertical)

Girl (horizontal)

Boy on a phone (horizontal)

10 (vertical)

K O N A K

KONAK

KOLİ

KİLO

KOKLA

OKAN

KONİ

ALO

ON





KOL



## Etkinlik O, o Sesi Bul, yaz.

alo alo konak alo konak alo konak alo konak okul kol koni koni koni okul okul okul on kol okul on okul on okul

4



## Etkinlik O, o Sesi Oku.

Anne iki koli  al.

 a  ekle.

On kilo  al.

Okan  kokla.

Elek ile  ele.

Okan on kilo  ele.



Etkinlik M, m Sesi Yaz.

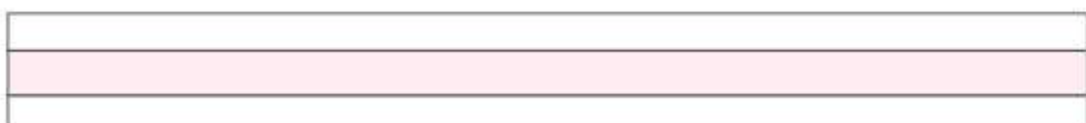
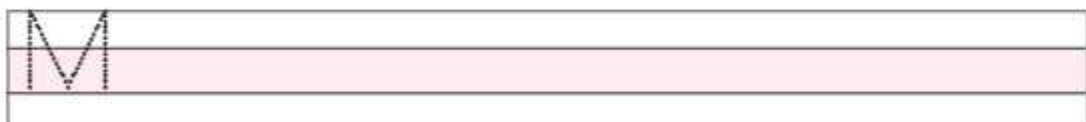
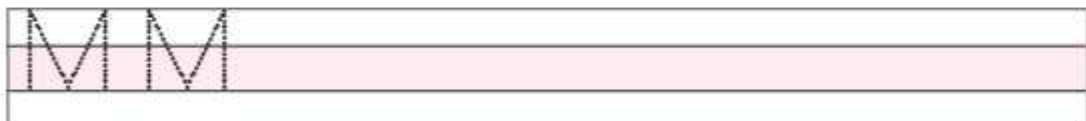
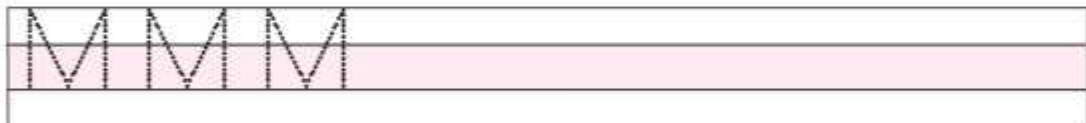
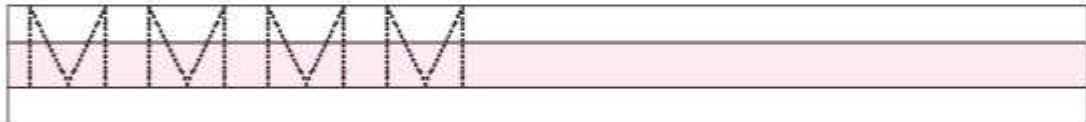
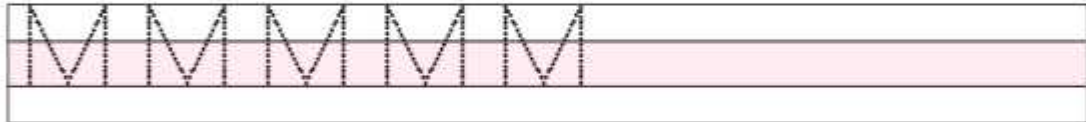
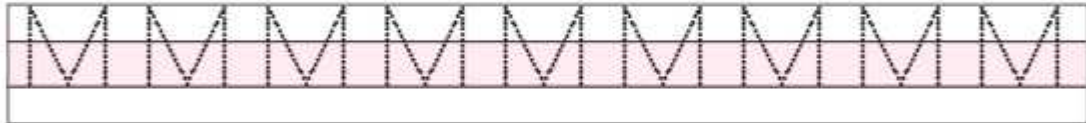



Etkinlik M, m Sesi Yaz.

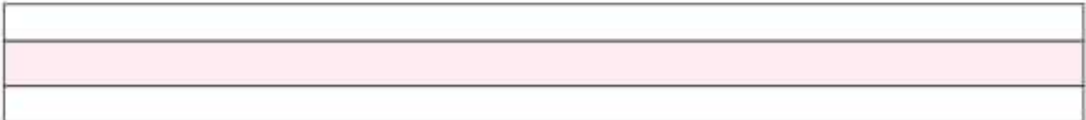
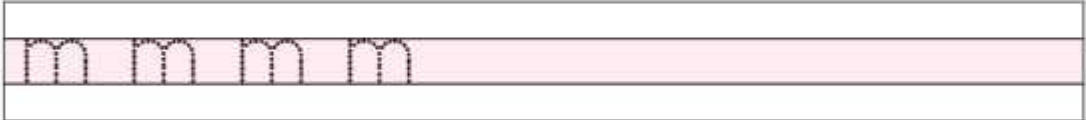
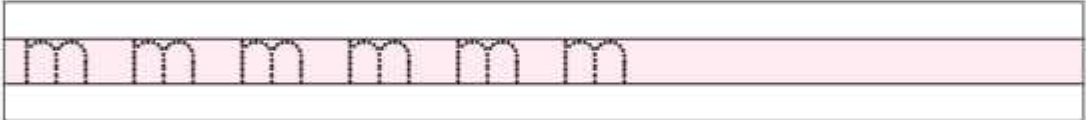
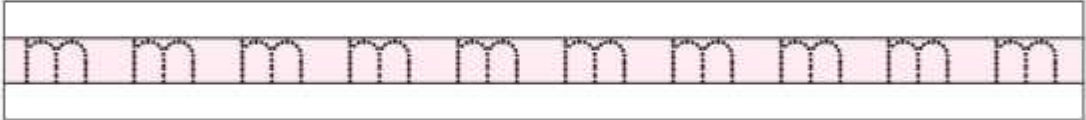

3

Etkinlik M, m Sesi

Bul, kes (71. sayfadan),  
birleştir, yapıştır.



3

Etkinlik M, m Sesi

Bul, kes, birleştir,  
yapıştır (70. sayfaya).

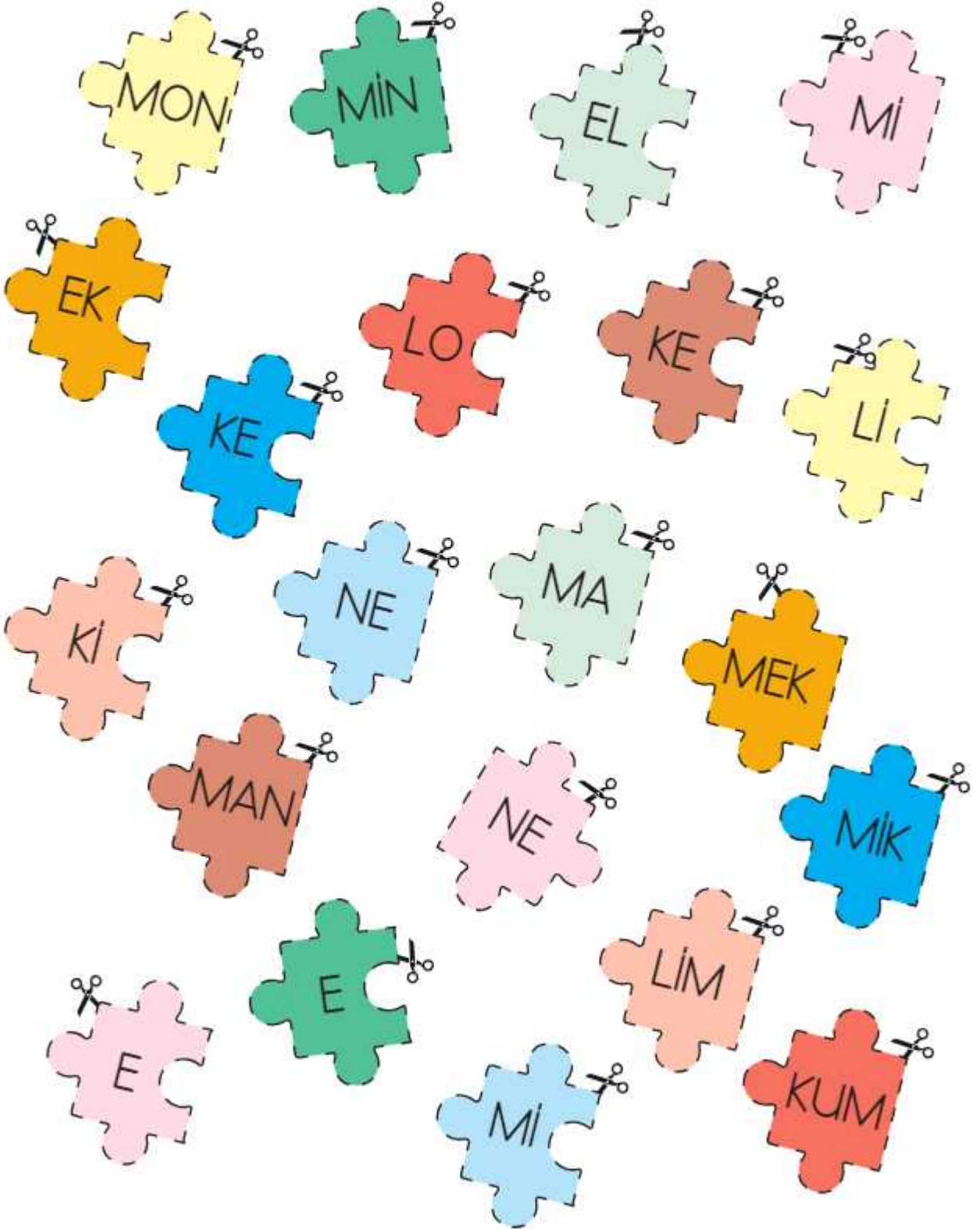

**3** Etkinlik M, m Sesi



## 4

## Etkinlik M, m Sesi Bul, boy.

1. EKMEK



6. LOKUM



2. KEMİK



7. KUM



3. KEMAN



8. MALA



4. KİLİM



9. ELMA



5. LİMON



10. MİNE



|   |   |   |   |   |   |   |   |   |   |
|---|---|---|---|---|---|---|---|---|---|
| O | L | İ | M | O | N | U | İ | M | U |
| E | U | K | O | M | L | O | K | U | M |
| K | U | M | K | O | M | İ | N | E | U |
| L | İ | E | K | M | E | K | O | U | M |
| K | E | M | İ | K | K | E | M | A | N |
| İ | K | E | L | M | A | O | U | İ | M |
| K | A | L | E | M | İ | M | A | L | A |
| M | U | U | İ | E | K | İ | L | İ | M |

5.

Etkinlik M, m Sesi

Bak, anlat.





Etkinlik M, m Sesi Bul, boya, yaz.

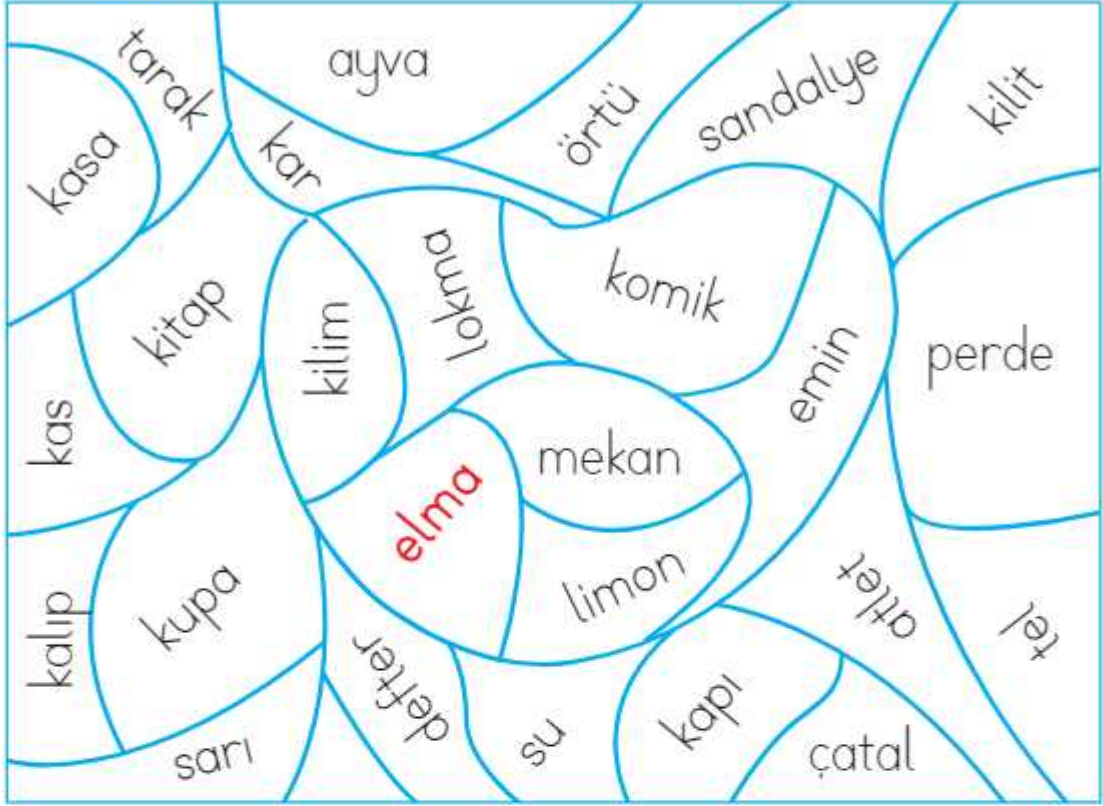

|      |
|------|
| elma |
|      |
|      |
|      |
|      |
|      |
|      |
|      |
|      |
|      |

# 7.

## Etkinlik M, m Sesi

Bul, yaz.

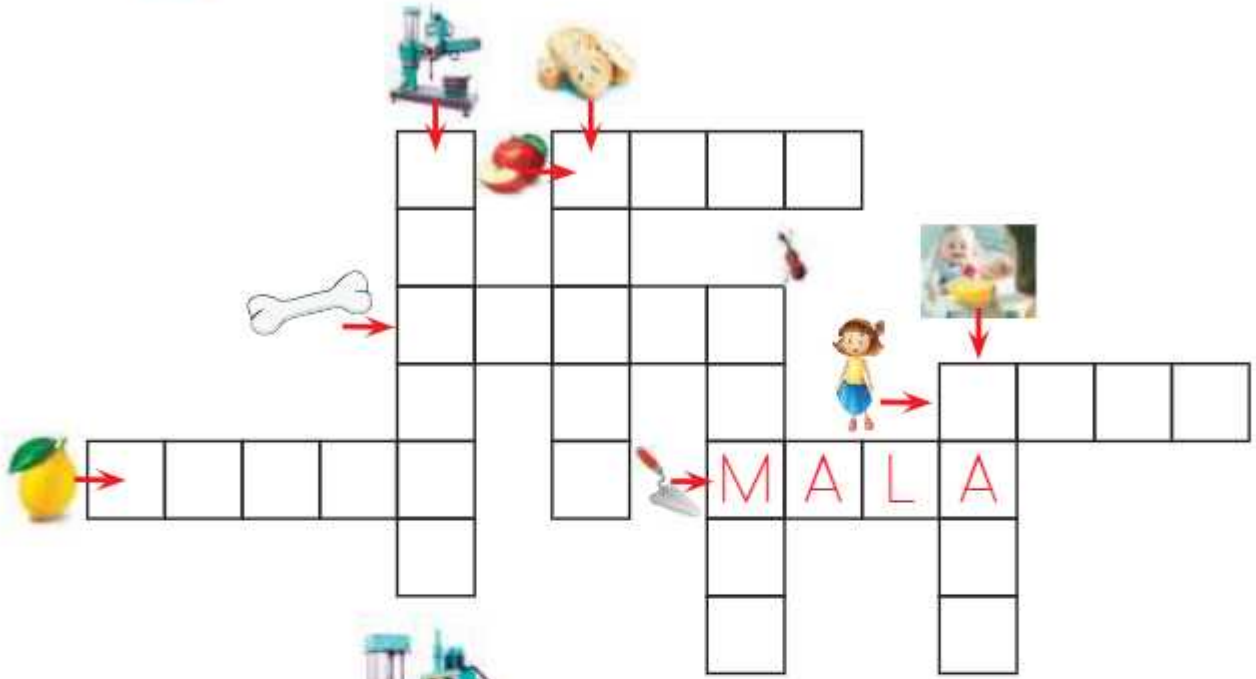

MAKİNA



KEMAN



MALA



LİMON



KEMİK



EKMEK



MAMA



MİNE



ELMA





Etkinlik M, m Sesi Oku, yaz.

Emel



kimin?

Emel elma kimin?

Mine



alma.

|  |
|--|
|  |
|  |
|  |

Melek



al.

|  |
|--|
|  |
|  |
|  |

Kemal o



.

|  |
|--|
|  |
|  |
|  |

Kenan o



.

|  |
|--|
|  |
|  |
|  |

## 9

## Etkinlik M, m Sesi Oku, yaz.

1. ekmek



ekmek

2. limon



3. elma



4. keman



5. kilim



6. kemik



7. mine



8. lokum



9. emin



10. mala





Etkinlik U, u Sesi Yaz.

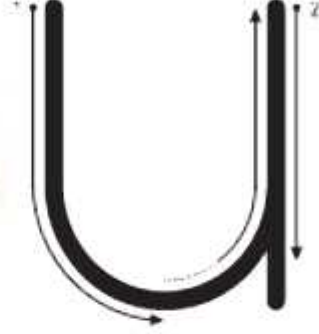

Handwriting practice lines for the letter 'U'. Each line consists of a top line, a middle line, and a bottom line. The first line contains ten dotted uppercase 'U's for tracing. The second line contains five dotted uppercase 'U's. The third line contains four dotted uppercase 'U's. The fourth line contains three dotted uppercase 'U's. The fifth line contains two dotted uppercase 'U's. The sixth line contains one dotted uppercase 'U'. The remaining three lines are blank for independent practice.

# 2.

## Etkinlik U, u Sesi Yaz.



Handwriting practice row 1: A row of ten dashed uppercase 'U' characters on a pink background for tracing.

Handwriting practice row 2: A row of seven dashed uppercase 'U' characters on a pink background for tracing.

Handwriting practice row 3: A row of five dashed uppercase 'U' characters on a pink background for tracing.

Handwriting practice row 4: A row of four dashed uppercase 'U' characters on a pink background for tracing.

Handwriting practice row 5: A row of two dashed uppercase 'U' characters on a pink background for tracing.

Handwriting practice row 6: A row with one dashed uppercase 'U' character on a pink background for tracing.

Handwriting practice row 7: A blank row with a pink background for independent practice.

Handwriting practice row 8: A blank row with a pink background for independent practice.



# 3

## Etkinlik) U, u Sesi Yaz.

1. KOKU



7. KUKLA



2. OKUL



8. KULAK



3. KULE



9. KUM



4. LOKUM



10. NUMAN



5. OKU



11. UN



6. MUM



|   |   |   |   |   |   |   |   |
|---|---|---|---|---|---|---|---|
| K | O | K | U | L | A | K | K |
| L | K | A | L | O | K | U | M |
| O | U | K | K | İ | E | O | L |
| U | K | U | U | N | M | K | E |
| N | A | L | M | O | K | U | L |
| İ | L | E | N | U | M | A | N |
| K | U | K | L | A | M | U | M |

4

Etkinlik

U, u Sesi

Bul, yaz.



KUKLA

KULE

OKUL

LOKUM

UN

KULAK

KUM

5.

Etkinlik U, u Sesi Bak, anlat.



# 6.

## Etkinlik U, u Sesi Oku, seç.

1. Un ele.

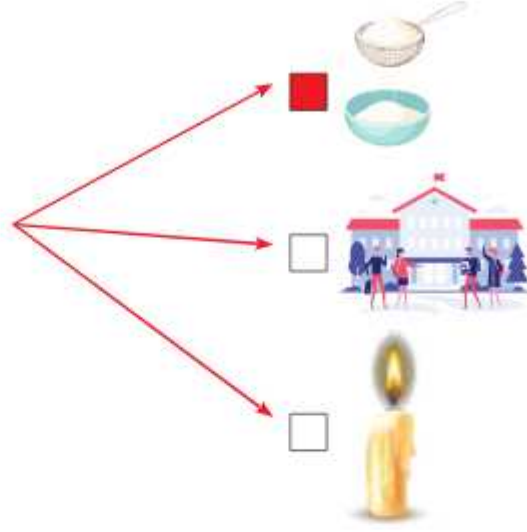

2. Okan o kule.

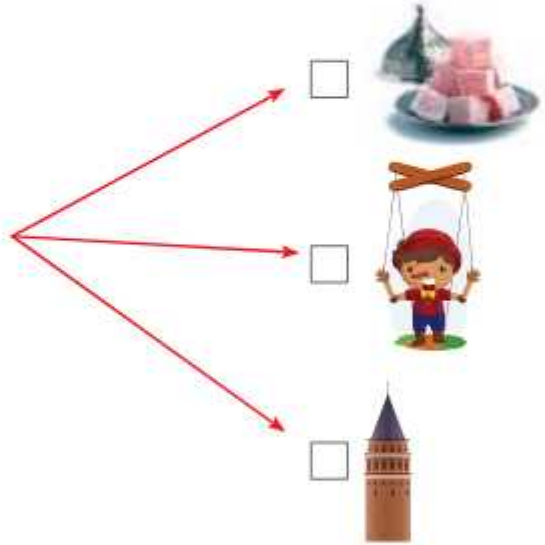

3. Oku, Numan oku.

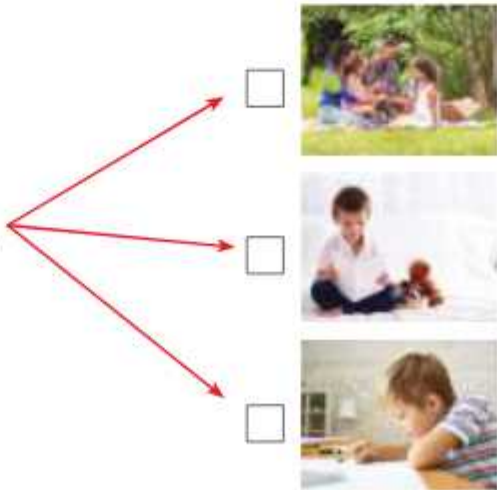



Etkinlik U, u Sesi Oku, seç.

4. Kemal o kulak.



5. Ela ile Lale el ele.

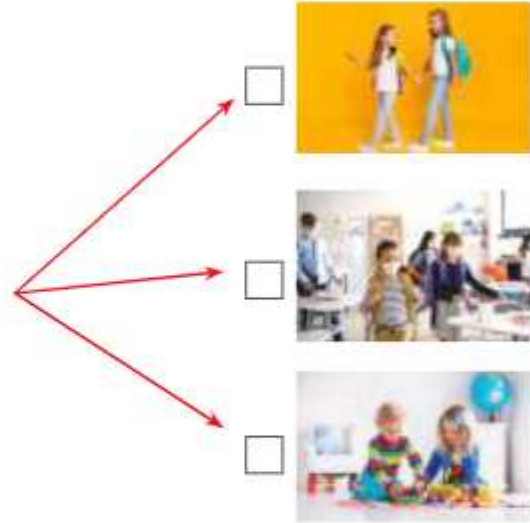

6. Okan ile Ela lokum al.

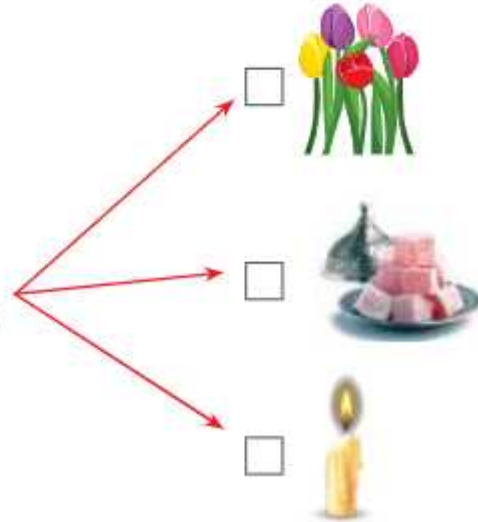



Etkinlik T, t Sesi Yaz.

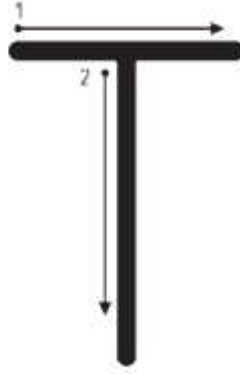

Handwriting practice line with a pink shaded middle section and dotted uppercase 'T' characters for tracing.

Handwriting practice line with a pink shaded middle section and dotted uppercase 'T' characters for tracing.

Handwriting practice line with a pink shaded middle section and dotted uppercase 'T' characters for tracing.

Handwriting practice line with a pink shaded middle section and dotted uppercase 'T' characters for tracing.

Handwriting practice line with a pink shaded middle section and dotted uppercase 'T' characters for tracing.

Handwriting practice line with a pink shaded middle section and dotted uppercase 'T' characters for tracing.

Blank handwriting practice line with a pink shaded middle section.

Blank handwriting practice line with a pink shaded middle section.





Etkinlik

T, t Sesi

Bul, boya.

1. TOKA



7. KOLTUK



2. ATLET



8. AT



3. MANTO



9. KİLİT



4. TEKNE



10. ETEK



5. KUTU



11. TİLKİ



6. OLTA



|   |   |   |   |   |   |   |   |   |   |
|---|---|---|---|---|---|---|---|---|---|
| T | E | O | M | L | A | T | L | E | T |
| K | O | L | T | A | M | A | N | T | O |
| T | E | T | O | K | A | T | K | E | K |
| T | L | A | U | K | T | N | U | K | S |
| İ | T | İ | K | İ | L | İ | T | E | E |
| L | A | T | O | K | E | K | U | L | T |
| K | T | E | L | A | T | E | K | N | E |
| İ | O | L | T | K | O | L | T | U | K |



4

Etkinlik T, t Sesi Bul, yaz.

MELTEM

MELTEM

ATLET

OLTA

OTEL

TEL

NOTA

METİN

KİLİT

## 5

## Etkinlik

## T, t Sesi

Bul, yaz.



k n e t e

tekne



t l e a t



k o t a



t l i k i



m n o t a



t e k e



o l k u t k



Etkinlik T, t Sesi Oku, yaz.



Meltem



kutu



kutu



toka

al.



İlke ..... atma.



Mete ..... tut.



Tuna.....i tat.



Ela o .....



Etkinlik T, t Sesi Yaz.



etek





Etkinlik T, t Sesi Bul, boya ve yaz.

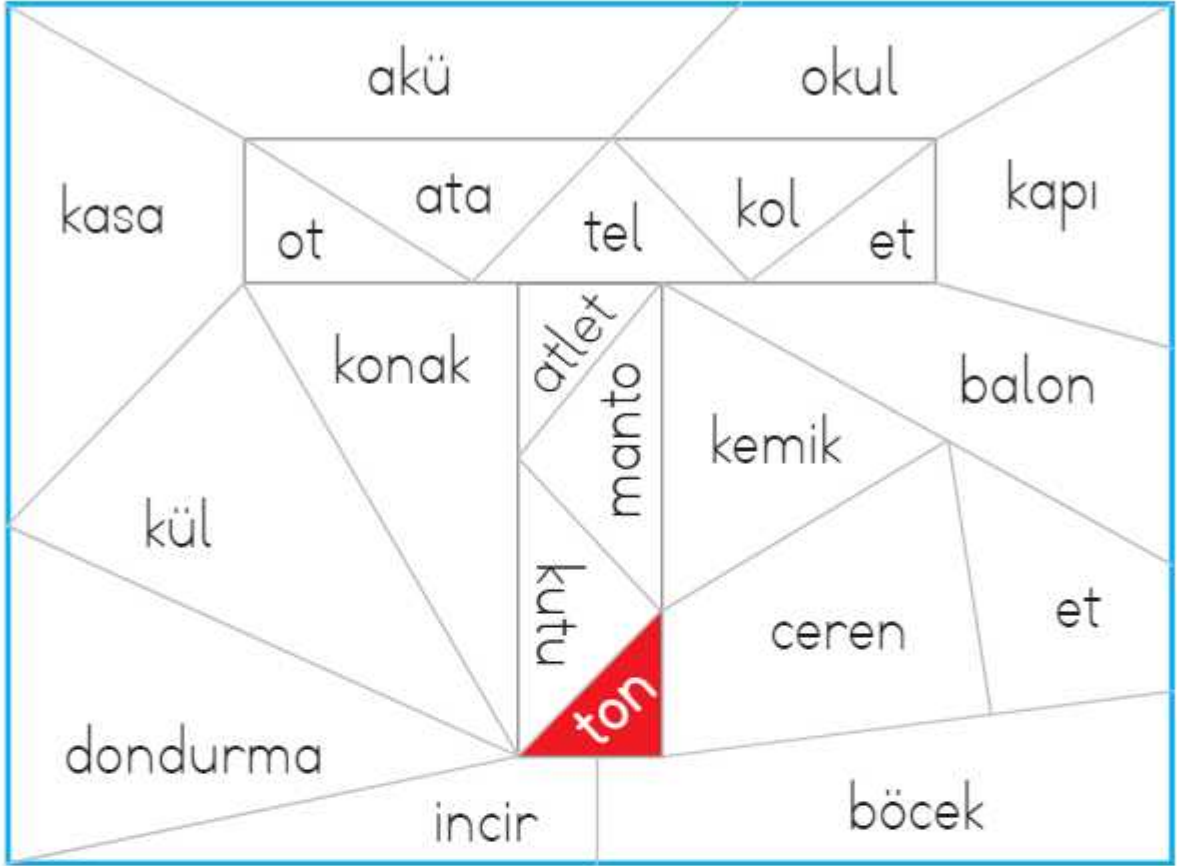

|     |
|-----|
| ton |
|     |
|     |
|     |
|     |
|     |
|     |
|     |



Etkinlik Ü, ü Sesi Yaz.



Handwriting practice lines for the letter 'U'. Each line consists of a top line, a middle line, and a bottom line. The first line contains ten dotted 'U's for tracing. The second line contains six dotted 'U's. The third line contains five dotted 'U's. The fourth line contains four dotted 'U's. The fifth line contains two dotted 'U's. The sixth line contains one dotted 'U'. The remaining three lines are blank for independent practice.



Etkinlik Ü, ü Sesi Yaz.

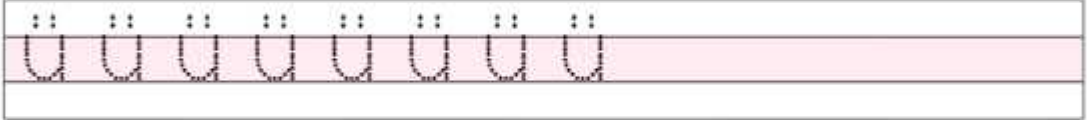
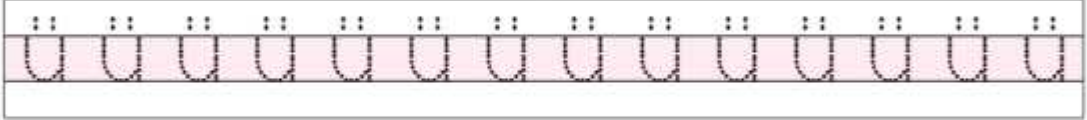
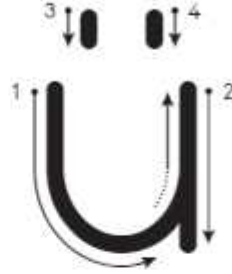

3

Etkinlik Ü, ü Sesi Bul, boya.

ÜTÜ



TÜNEL



ÜLKE



TÜL



KÜTÜK



AKÜ



KÜL



ÜNAL



ÜLKÜ



|   |   |   |   |   |   |   |   |
|---|---|---|---|---|---|---|---|
| Ü | Ü | K | T | Ü | L | N | K |
| T | L | K | L | İ | A | Ü | Ü |
| Ü | K | Ü | L | K | E | N | O |
| E | Ü | L | A | K | O | A | E |
| A | T | İ | Ü | N | A | L | K |
| K | T | Ü | N | E | L | O | N |
| Ü | L | K | K | Ü | T | Ü | K |



4

Etkinlik Ü, ü Sesi Anlat, canlandır.



# 5.

## Etkinlik Ü, ü Sesi Oku, seç.

Ünal, o Atam.

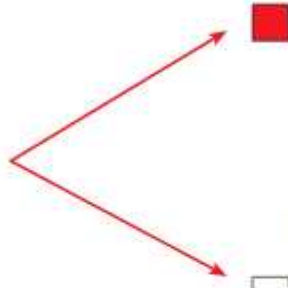

Ülkü, onu ütüle.

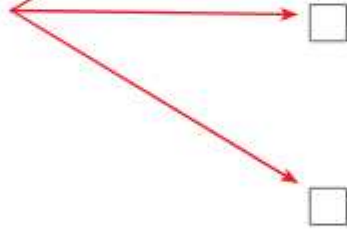

Ümit, tüm ekmek al.

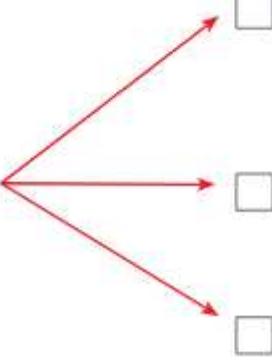



Etkinlik Ü, ü Sesi Oku, seç.

Tülin, o atlet kimin?











Nüket, o kütük.



# 6.

## Etkinlik Ü, ü Sesi Bul, yaz.

ÜLKE

AKÜ

KÜL

TÜNEL

ÜTÜ

ÜNAL

TÜL

KÜTÜK

ÜLKÜ



Etkinlik Ü, ü Sesi Rengi bul, yaz.



ANAHTAR KELİME:





## Etkinlik Ü, ü Sesi Oku.

tünel tül kütük akü akü akü  
tünel tül tül kütük kül akü  
tünel tül kütük kül akü  
ütü tül kütük kül akü  
ütü tünel tül kütük kül akü

2



## Etkinlik O, o Sesi Oku

ÜLKÜ

Ülkü ütü al.  
O tülü ütüle.  
Tek tek ütüle.  
Ülkü tülü tak.



Etkinlik Y, y Sesi Yaz.

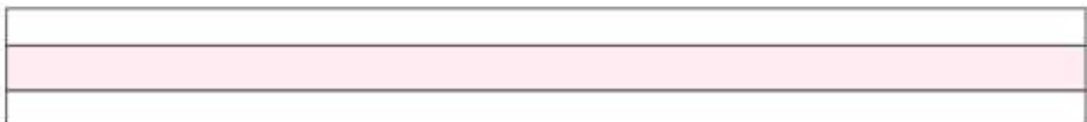
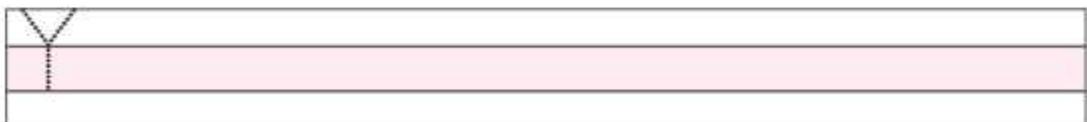
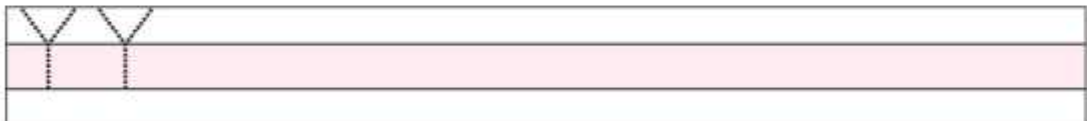
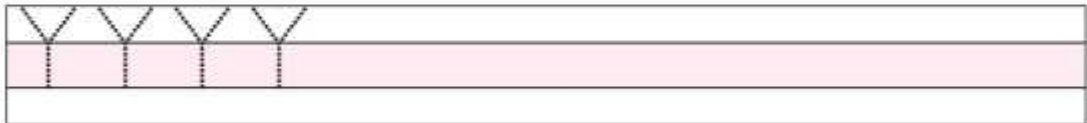
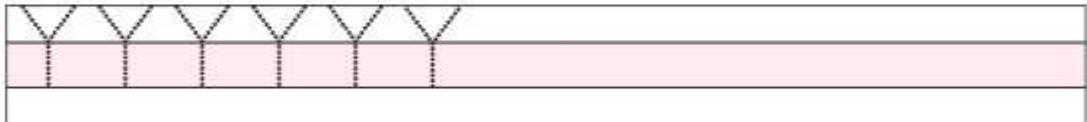
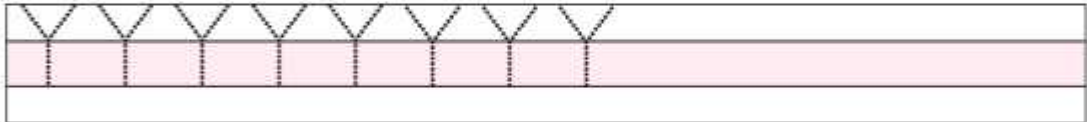
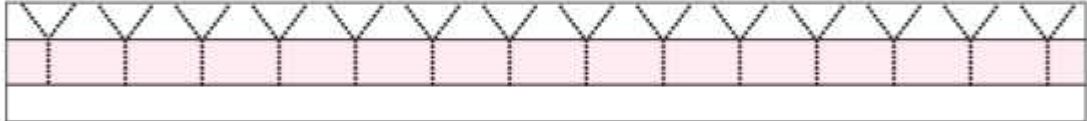



Etkinlik Y, y Sesi Yaz.

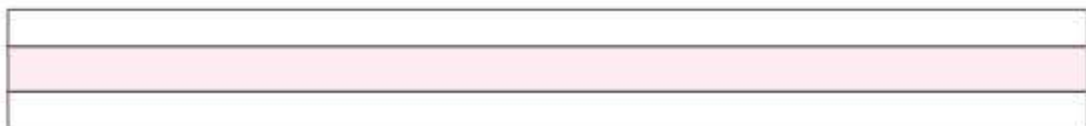
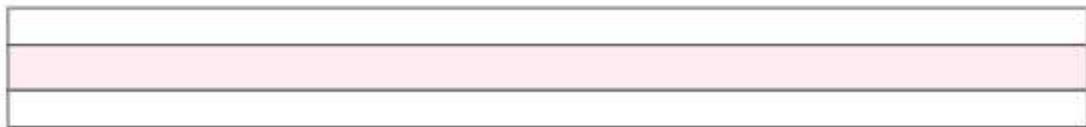
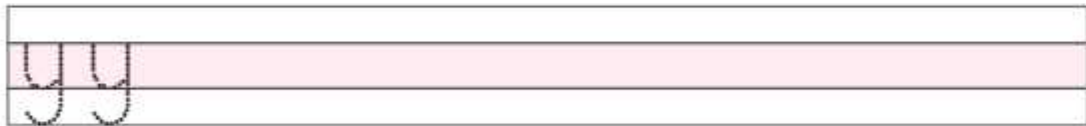
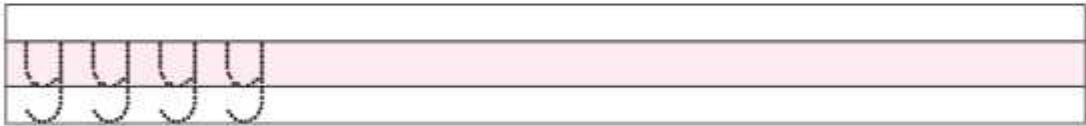
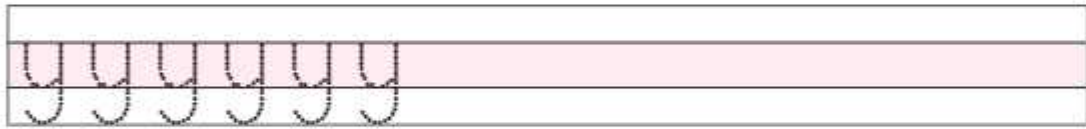
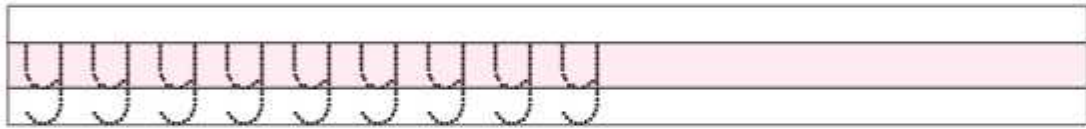
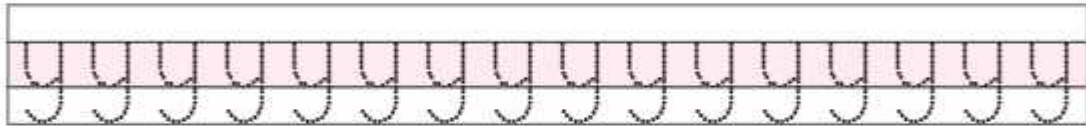



# 3

## Etkinlik Y, y Sesi Yaz.

YAYA



YATAK



KAYAK



YEMEK



YOL



YUMAK



AYAK



KAYA



AYNA



OYA



AY



KOYUN



OYNA



YE



|   |   |   |   |   |   |   |   |   |
|---|---|---|---|---|---|---|---|---|
| Y | İ | Y | E | M | E | K | A | K |
| U | E | T | U | Y | A | T | A | K |
| M | Y | A | Y | A | K | A | Y | A |
| A | A | T | O | A | Y | A | K | O |
| K | Ü | N | L | K | O | Y | U | N |
| Ü | K | A | Y | N | A | O | A | Y |
| O | Y | A | E | K | A | Y | A | K |
| T | O | Y | N | A | M | Y | E | U |

4.

Etkinlik Y, y Sesi Bul, yaz.

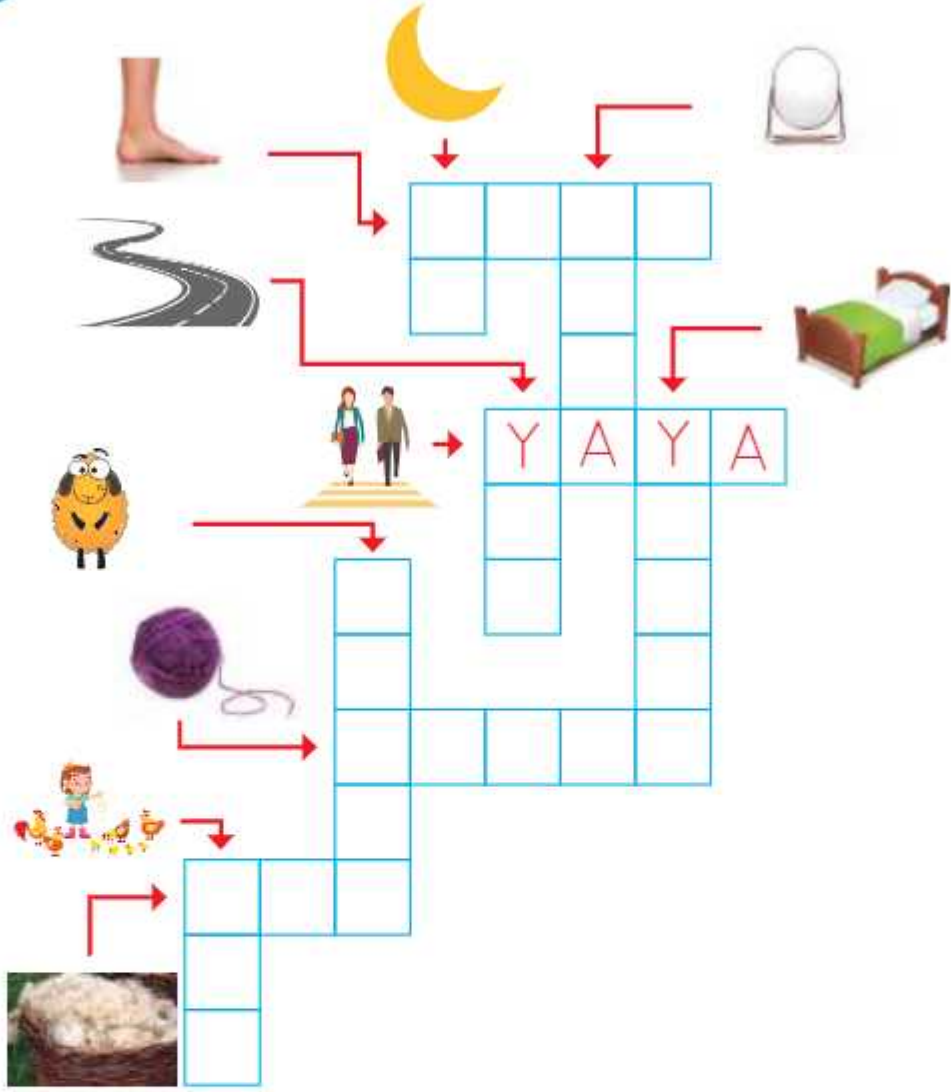

YAYA



AY



YEM



AYNA



YATAK



YÜN



KOYUN



YUMAK



YOL



AYAK



# 5.

## Etkinlik Y, y Sesi

Bul, kes, birleştir,  
yapıştır, yaz (109,  
110. sayfalara).

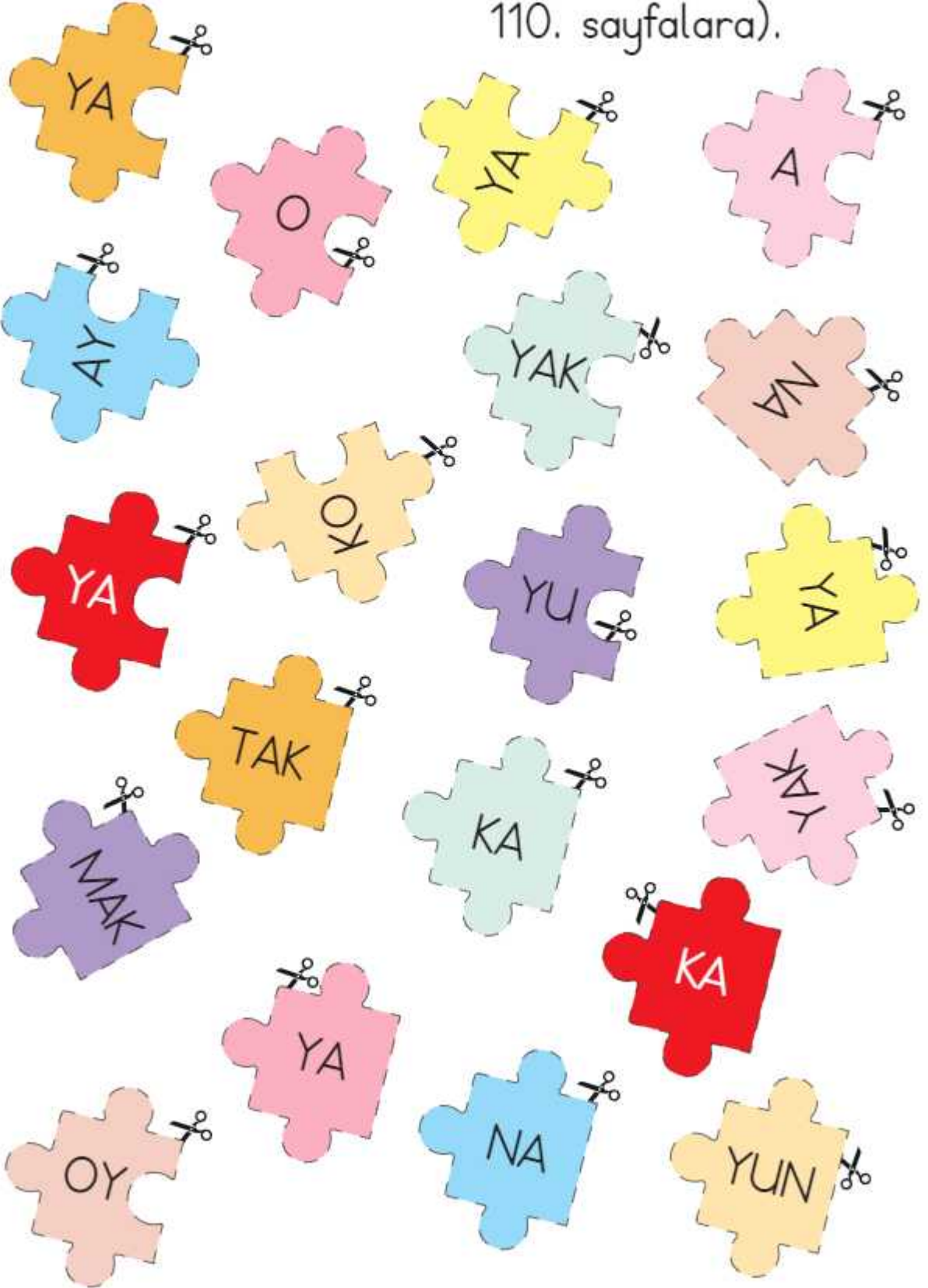

**5** Etkinlik Y. y Sesi

# 5.

## Etkinlik Y, y Sesi Yapıştır, yaz.

yaya



|  |
|--|
|  |
|  |
|  |

yatak



|  |
|--|
|  |
|  |
|  |

ayna



|  |
|--|
|  |
|  |
|  |

oyna



|  |
|--|
|  |
|  |
|  |

yumak



|  |
|--|
|  |
|  |
|  |

# 5

## Etkinlik

## Y, y Sesi

Yapıştır, yaz.

Oya



|  |
|--|
|  |
|  |
|  |

koyun



|  |
|--|
|  |
|  |
|  |

kayak



|  |
|--|
|  |
|  |
|  |

ayak



|  |
|--|
|  |
|  |
|  |

kaya



|  |
|--|
|  |
|  |
|  |

# 6.

Etkinlik Y, y Sesi Bul, anlat, yaz.



1. yatak

5.

2.

6.

3.

7.

4.

8.



Etkinlik

Y, y Sesi

Oku, yaz.

Oya



'a ot at.

|  |
|--|
|  |
|  |
|  |

Yaman



ye.

|  |
|--|
|  |
|  |
|  |

Kaya



al.

|  |
|--|
|  |
|  |
|  |

Aylin yaya



u iyi.

|  |
|--|
|  |
|  |
|  |

Kutay



ile oyun oyna.

|  |
|--|
|  |
|  |
|  |





Etkinlik Y, y Sesi

İçinde "y" olanı  
bul, yaz.

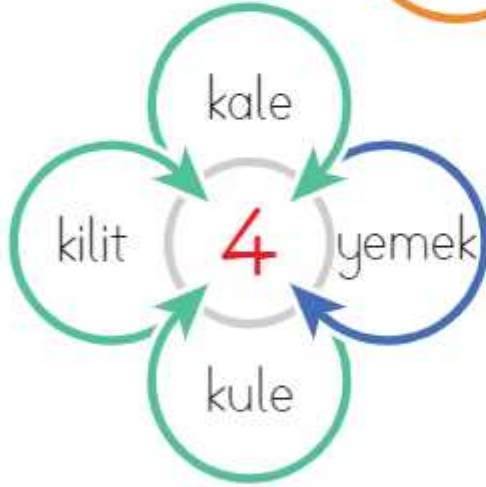

Aylın

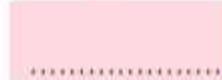
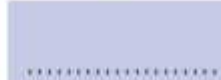
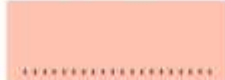



Etkinlik Ö, ö Sesi Yaz.

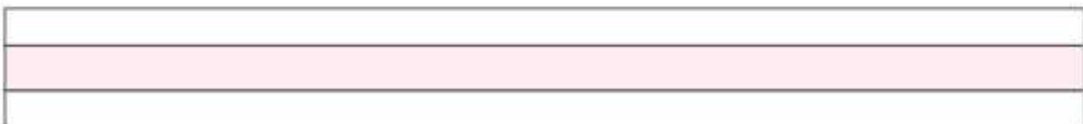
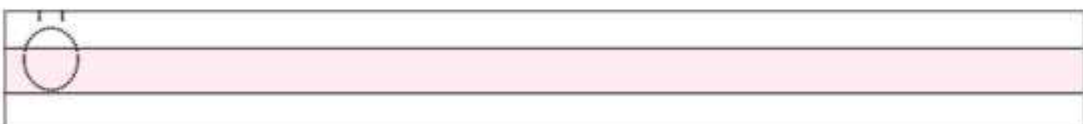
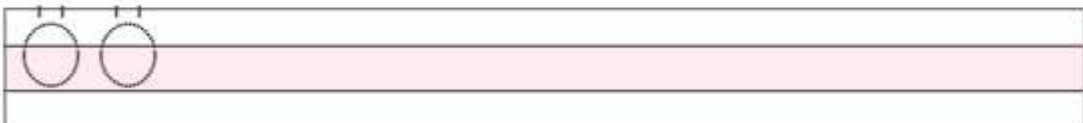
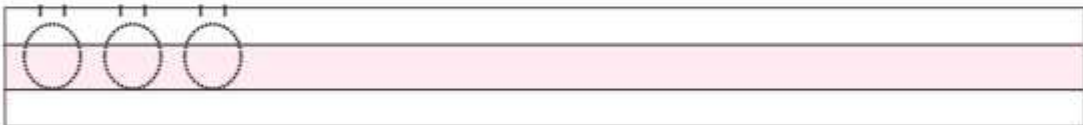
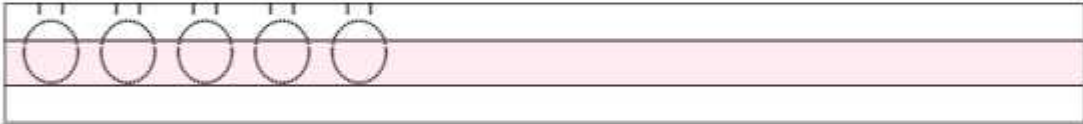
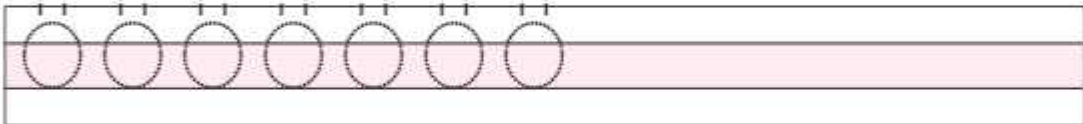
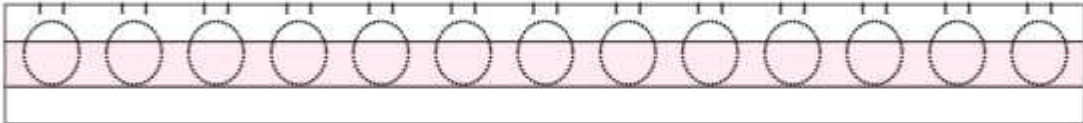



Etkinlik Ö, ö Sesi Yaz.

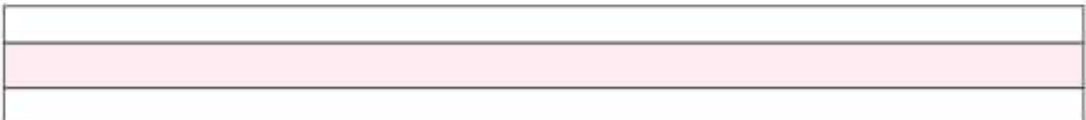
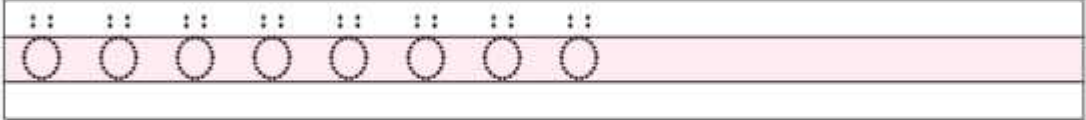
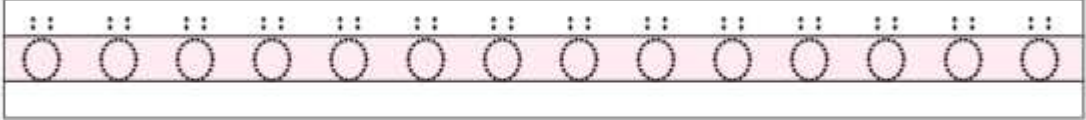

# 3

Etkinlik Ö, ö Sesi "ö" sesini bul, işaretle.



- kök
- köy
- kal



- önlük
- okul
- lale



- at
- ot
- öt



- kalem
- ördek
- nane



- köy
- kal
- kat



- yak
- yön
- yan

# 4

## Etkinlik Ö, ö Sesi Oku, eşle.

1. Yaman iki kök nane al.



2. Mine öykü oku.



3. Ümit önlük tak.



4. Nine öykü anlat.



5. Öykü ile Metin oyun ayna.



5.

Etkinlik Ö, ö Sesi Bak, anlat, çiz.

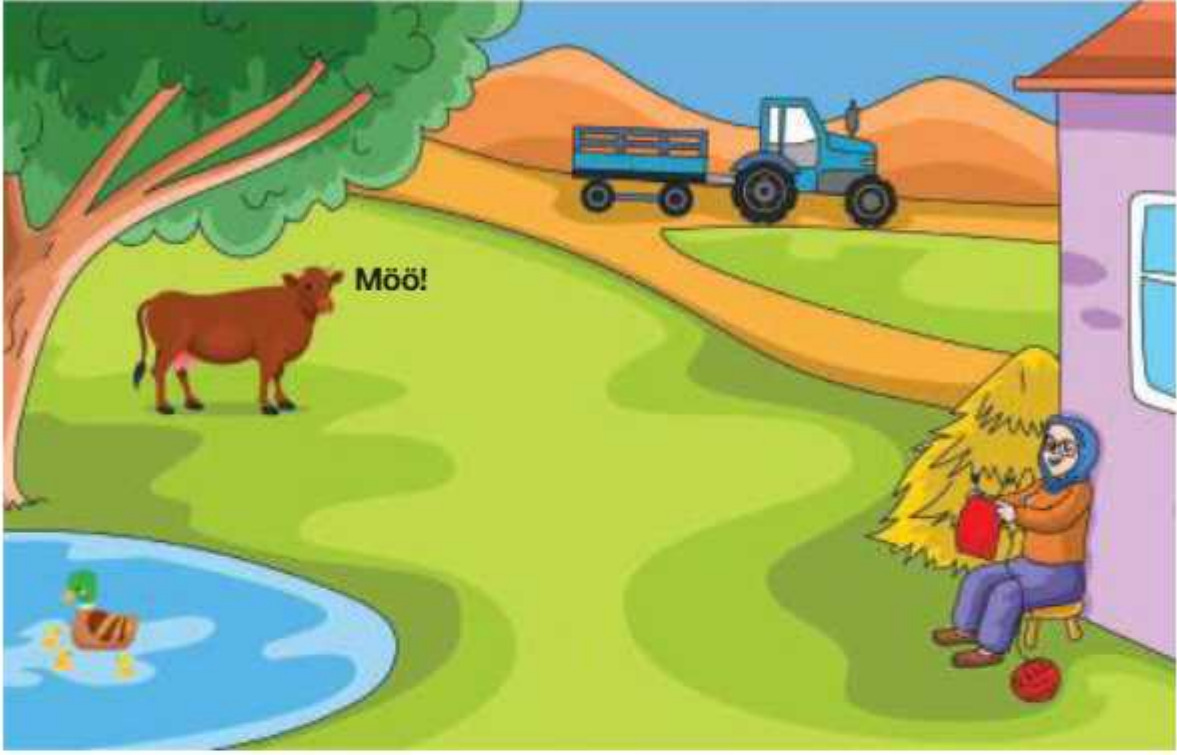

# 6.

Etkinlik Ö, ö Sesi Bak, oku, yaz.

|    |  |  |  |  |
|----|--|--|--|--|
| ön |  |  |  |  |
|----|--|--|--|--|

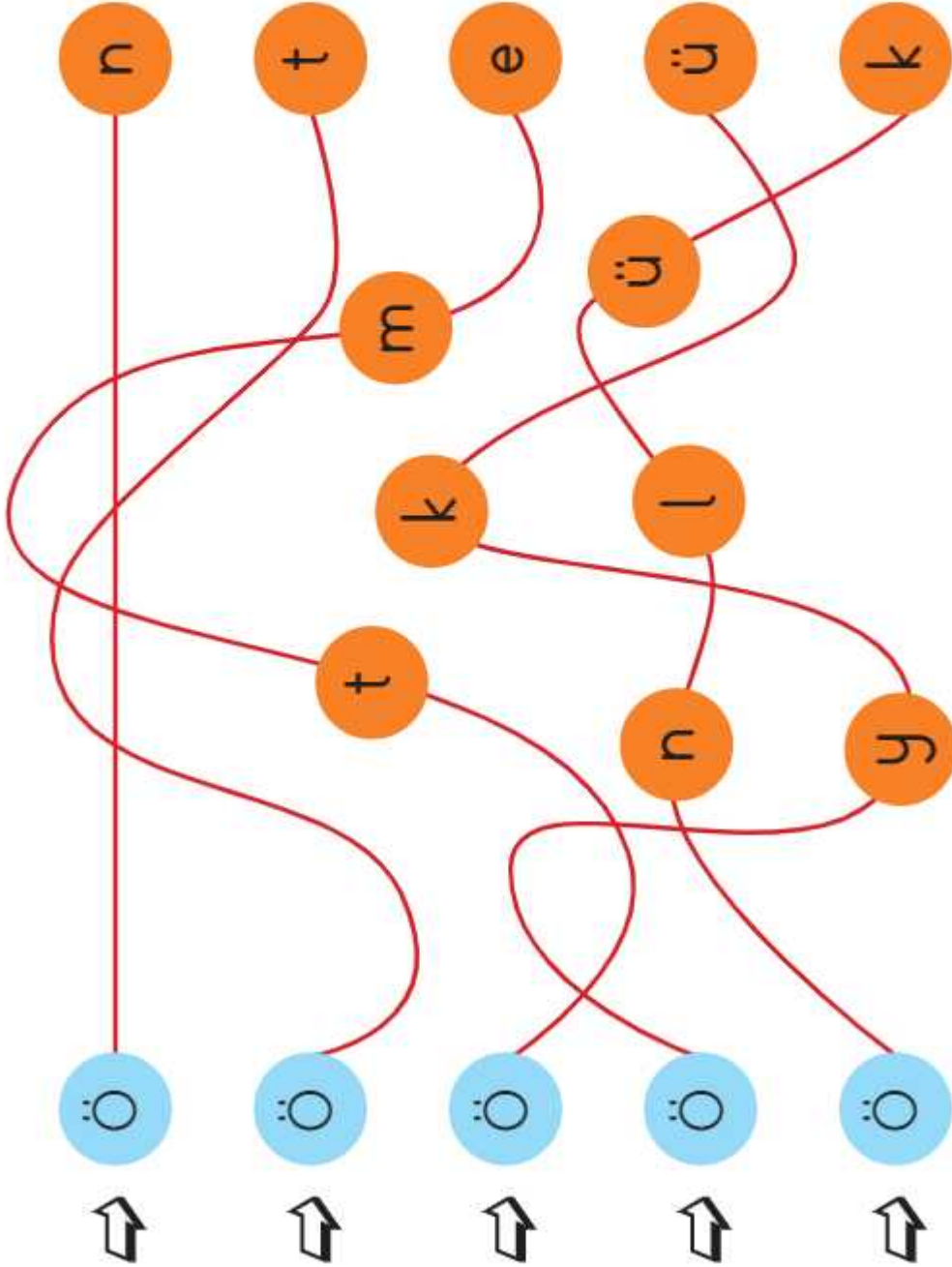



Etkinlik

Ö, ö Sesi

Bak, oku, yaz.

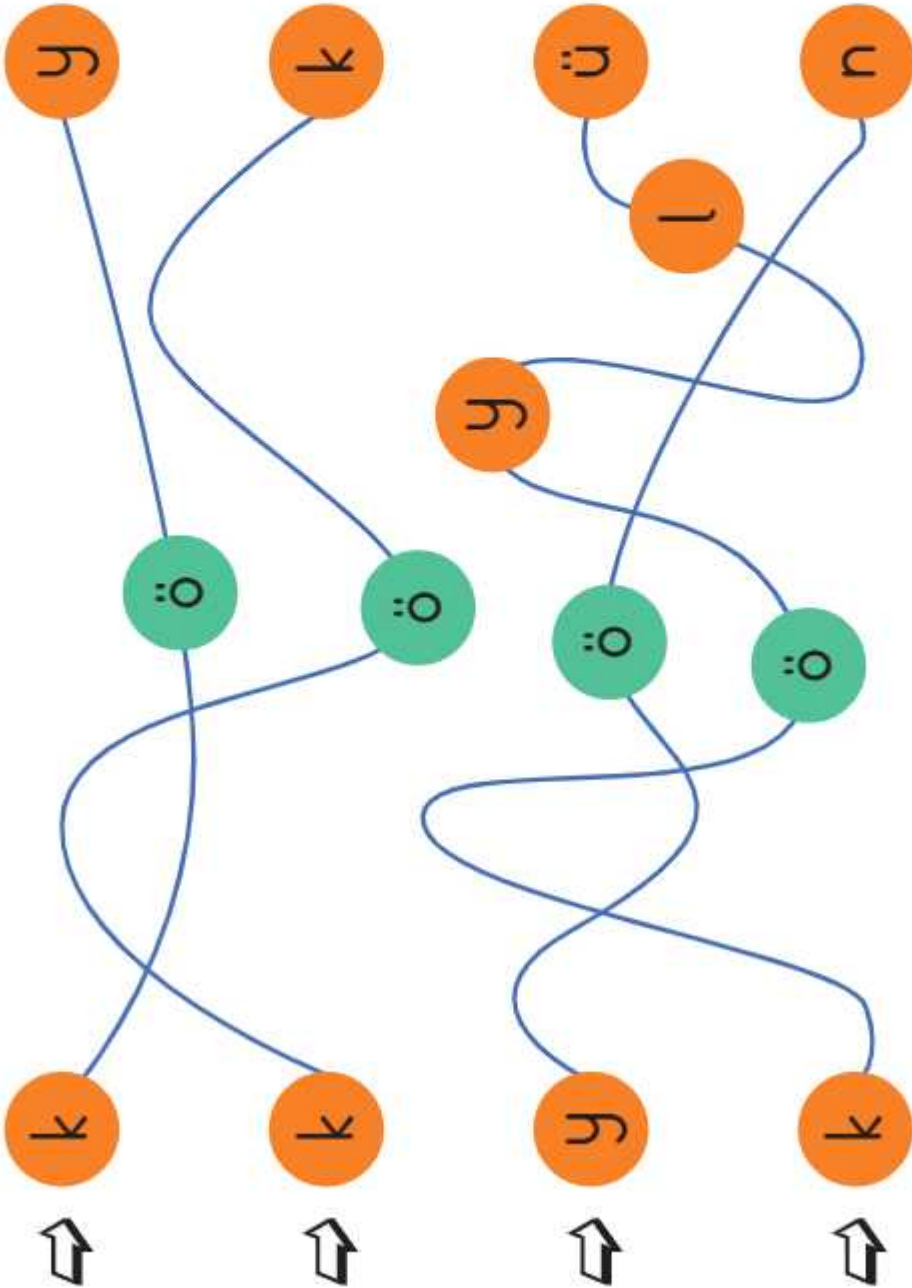
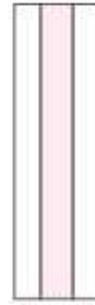
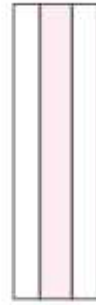
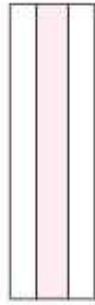





Etkinlik R, r Sesi Yaz.

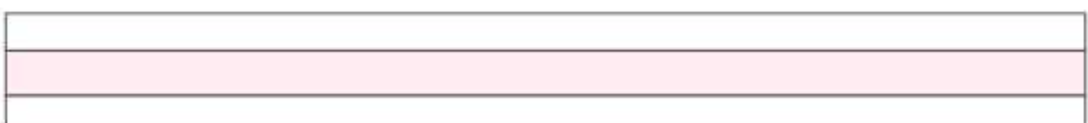
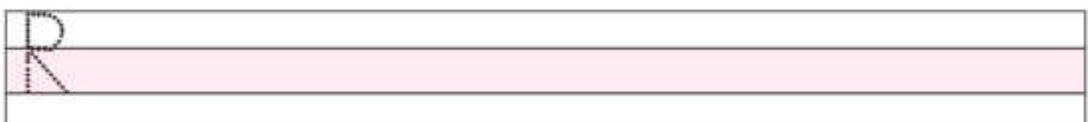
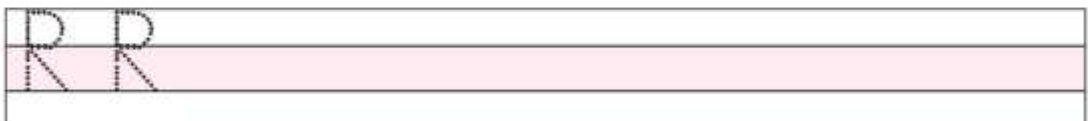
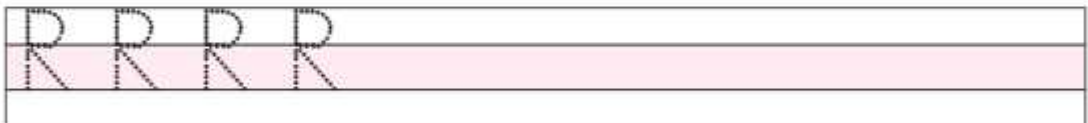
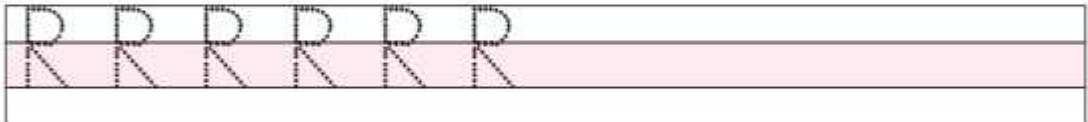
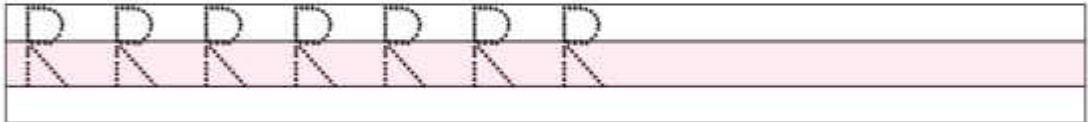
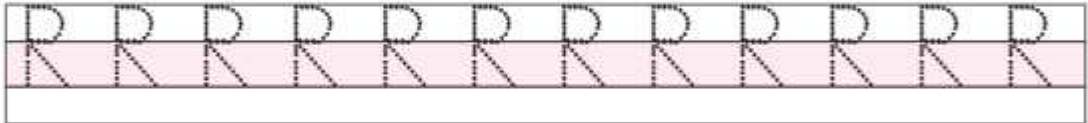



Etkinlik R, r Sesi Yaz.



Handwriting practice lines for the letter 'r'. Each line consists of a top line, a middle line, and a bottom line. The first line is filled with a continuous row of dashed lowercase 'r's for tracing. The following lines contain a decreasing number of dashed lowercase 'r's for tracing: the second line has 10, the third has 6, the fourth has 4, the fifth has 2, and the sixth has 1. The remaining three lines are blank for independent practice.



Etkinlik R, r Sesi Bak, anlat.





Etkinlik R, r Sesi

Oku, yaz, çiz.

a. Ömer mısır yer.

|  |
|--|
|  |
|  |
|  |

|  |
|--|
|  |
|--|

b. Onur öykü okur.

|  |
|--|
|  |
|  |
|  |

|  |
|--|
|  |
|--|

c. Kerem kürek al.

|  |
|--|
|  |
|  |
|  |

|  |
|--|
|  |
|--|

ç. Ali robotu tamir et.

|  |
|--|
|  |
|  |
|  |

|  |
|--|
|  |
|--|

d. İrem iki armut al.

|  |
|--|
|  |
|  |
|  |

|  |
|--|
|  |
|--|

## 5

## Etkinlik R, r Sesi Bul, boya.

tören kar roket kurt  
tamir orman nar erik

|   |   |   |   |   |   |   |   |
|---|---|---|---|---|---|---|---|
| e | t | ö | r | e | n | k | i |
| ö | n | r | o | k | e | t | l |
| t | ö | r | n | e | k | k | a |
| l | l | e | y | n | a | r | e |
| k | a | r | y | e | r | i | k |
| t | k | u | r | t | l | ü | l |
| a | k | ö | t | a | m | i | r |
| o | r | m | a | n | k | ü | n |



# 6.

## Etkinlik R, r Sesi

Oku, kes (127. sayfadan), yapıştır, yaz.

OKU

YAPIŞTIR

YAZ

kürek



kürek

armut

kömür

orman

tarak

6.

Etkinlik R, r Sesi

Kes, yapıştır  
(126. sayfaya).

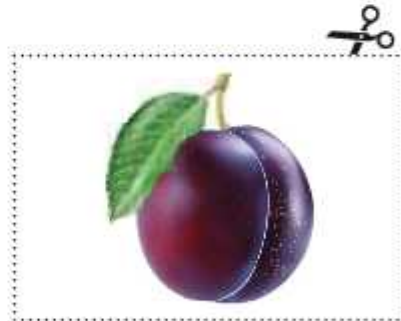
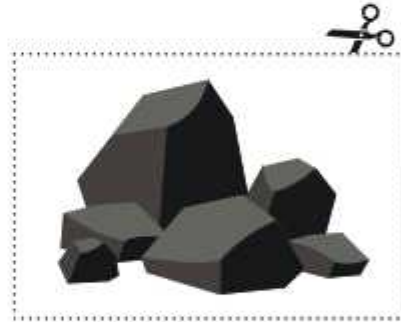
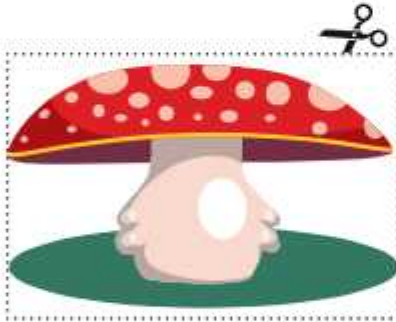
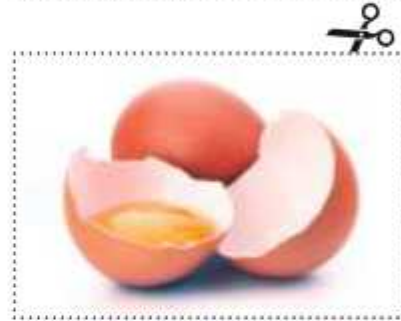
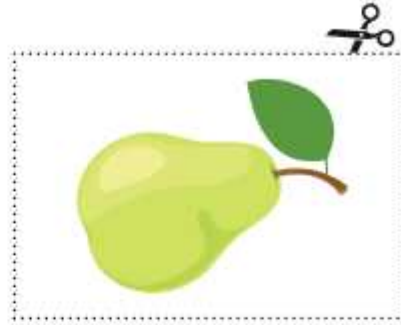
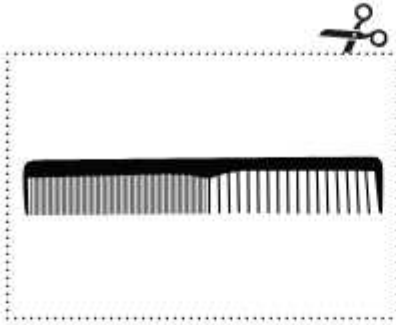

# 6. Etkinlik R, r Sesi





Etkinlik R, r Sesi

Oku, kes (127. sayfadan), yapıştır, yaz.

OKU

YAPIŞTIR

YAZ

roket



erik



mantar

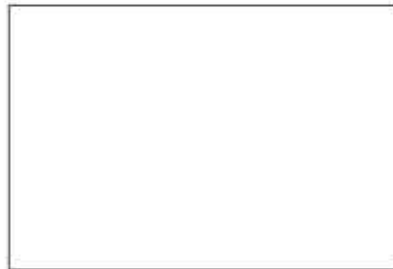

kamera

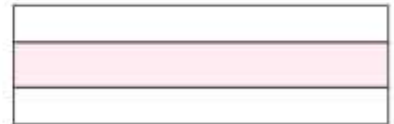
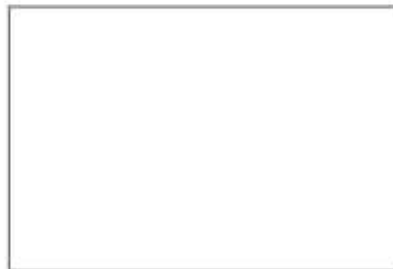

yumurta





Etkinlik R, r Sesi Yaz.

kurt örtü roket terlik armut  
orman yumurta kürek erik kömür



kurt



Blank writing lines for the word 'yumurta'.



Blank writing lines for the word 'terlik'.



Blank writing lines for the word 'orman'.



Blank writing lines for the word 'roket'.



Blank writing lines for the word 'erik'.

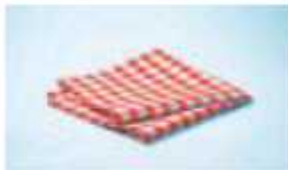

Blank writing lines for the word 'kötür'.



Blank writing lines for the word 'kürek'.



Blank writing lines for the word 'armut'.



Blank writing lines for the word 'kömür'.



Etkinlik R, r Sesi Eşle, yaz.

a. İlker  tak.



b. Rana  atla.

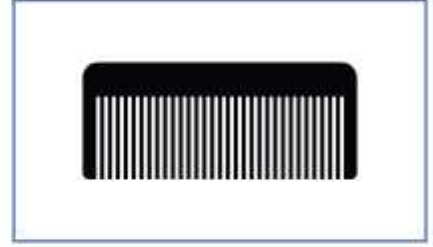

c. Ömer  ye.



ç. Ali  tamir et.

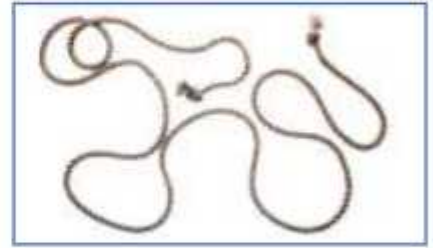

d. Kerem  kirli.



e. İrem  ile tara.







Etkinlik l, ı Sesi Yaz.



Handwriting practice lines for the letter 'l'. Each line consists of a top white line, a middle pink line, and a bottom white line. The first six lines have a dotted 'l' for tracing, with the length of the dotted line decreasing from left to right. The last two lines are completely blank for independent practice.

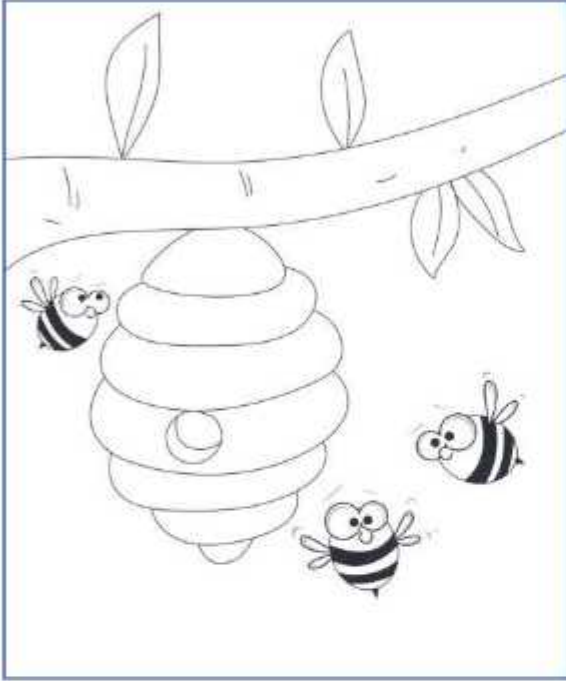

4.

Etkinlik

l, ı Sesi

Oku, bul, kes, yapıştır.

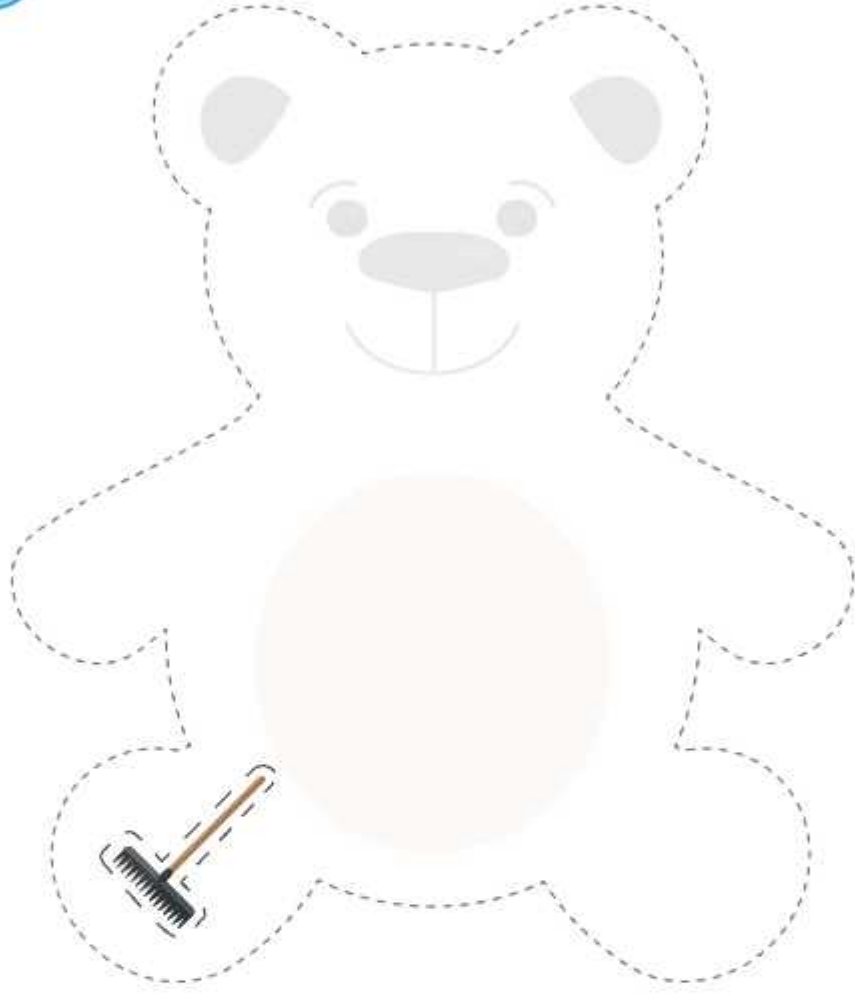

a. İtir **tırmık** al.



ç. Metin **atki** tak.



b. Kerem o **tirtil**.



e. Anne **kayık** yıka.



c. Ali **altı** ekmek al.



d. İrem **takı** tak.

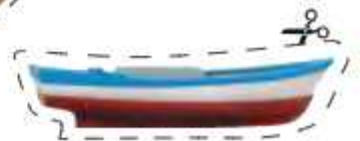



Etkinlik 4  
I, ı Sesi



## 5.

## Etkinlik

## I, ı Sesi

## Bul, işaretle.

a. Kerem atkı tak.



b. Akın atı otlat.



c. Ezgi erken kalktı.



ç. İrmak elini yıka.



d. Ayı armut yer.



e. Tarık balık tuttu.



# 6.

## Etkinlik

### l, ı Sesi

Bul, yaz.

a. makarna, Tarık, ye



Tarık

makarna

ye.

b. ör, Nine, atkı



Blank lines for writing the word 'ör'.

Blank lines for writing the word 'Nine'.

Blank lines for writing the word 'atkı'.

c. tatlı, al, Taner



Blank lines for writing the word 'tatlı'.

Blank lines for writing the word 'al'.

Blank lines for writing the word 'Taner'.



Etkinlik

l, ı Sesi

Bul, yaz.

ç. yer, ot, Tırtıl

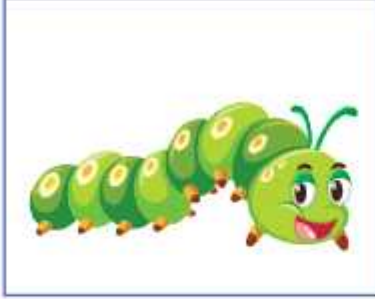

|  |
|--|
|  |
|  |
|  |

|  |
|--|
|  |
|  |
|  |

|  |
|--|
|  |
|  |
|  |

d. yırtık, Anne, etek



|  |
|--|
|  |
|  |
|  |

|  |
|--|
|  |
|  |
|  |

|  |
|--|
|  |
|  |
|  |

e. yer, Kerem, mantı



|  |
|--|
|  |
|  |
|  |

|  |
|--|
|  |
|  |
|  |

|  |
|--|
|  |
|  |
|  |



Etkinlik D, d Sesi Yaz.

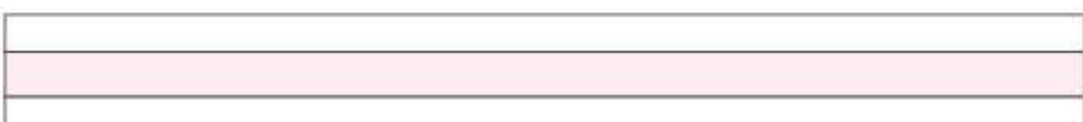
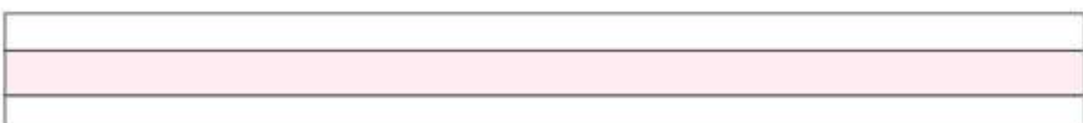
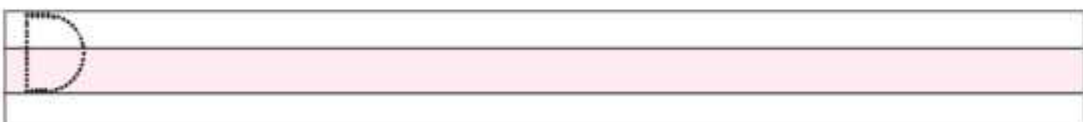
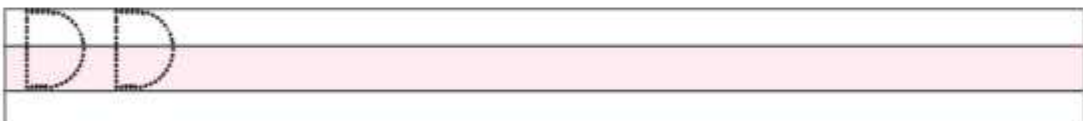
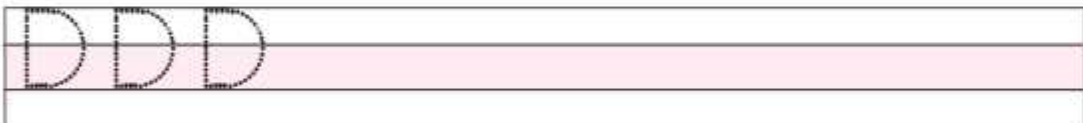
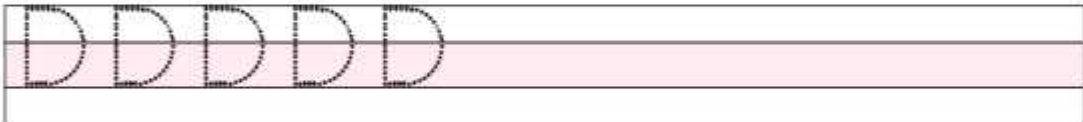
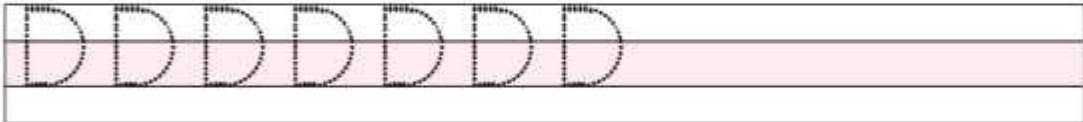
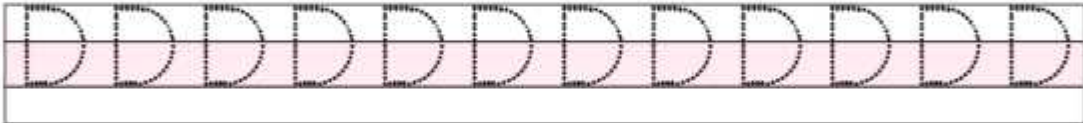



Etkinlik D, d Sesi Yaz.



Handwriting practice lines for the letter 'd'. Each line consists of a top line, a middle line, and a bottom line. The first line contains 15 dotted 'd's for tracing. The second line contains 8 dotted 'd's followed by a blank space. The third line contains 6 dotted 'd's followed by a blank space. The fourth line contains 4 dotted 'd's followed by a blank space. The fifth line contains 2 dotted 'd's followed by a blank space. The sixth line contains 1 dotted 'd' followed by a blank space. The seventh and eighth lines are completely blank for independent practice.



Etkinlik

D, d Sesi

Dinle/oku, yaz.

- Adem dondurma yedi.
- Adem dün dondurma yedi.
- Adem ile dedem dondurma yedi.
- Dedem sütlü dondurma yedi.
- Adem dört sütlü dondurma yedi.

Dinlediğin/okuduğun metne göre soruları cevapla.

a. Adem ne yedi?

Adem dondurma yedi.

b. Adem ne zaman dondurma yedi?

|  |
|--|
|  |
|  |
|  |

c. Adem kiminle dondurma yedi?

|  |
|--|
|  |
|  |
|  |

ç. Adem kaç sütlü dondurma yedi?

|  |
|--|
|  |
|  |
|  |

d. Dedem neli dondurma yedi?

|  |
|--|
|  |
|  |
|  |



Etkinlik D, d Sesi "d"yi bul, işaretle.

a.



b.

Kadir



Murat



Demet



Mehmet



Önder



Denizli



İzmir



Ardahan



Aydın



Hatay



5.

Etkinlik D, d Sesi

Bak, anlat.







Etkinlik D, d Sesi

Oku, yaz.

- a. Ümit dürüm aldı.  
Ümit ne aldı?

Ümit dürüm aldı.



- b. İrem doktor oldu.  
İrem ne oldu?

\_\_\_\_\_

\_\_\_\_\_

\_\_\_\_\_



- c. Tarık öykü okudu.  
Tarık ne okudu?

\_\_\_\_\_

\_\_\_\_\_

\_\_\_\_\_



- ç. Kedi mama yedi.  
Kedi ne yedi?

\_\_\_\_\_

\_\_\_\_\_

\_\_\_\_\_



- d. Dedem kilim dokudu.  
Dedem ne dokudu?

\_\_\_\_\_

\_\_\_\_\_

\_\_\_\_\_





Etkinlik

S, s Sesi

Yaz.



S S S S S S S S S S S S

S S S S S S S

S S S S S S

S S S S

S S

S



Etkinlik S, s Sesi Yaz.



S S S S S S S S S S S S S S S S

S S S S S S S S S

S S S S S S

S S S S

S S

S

3

Etkinlik

S, s Sesi

Bak, anlat, çiz.



4

Etkinlik

S, s Sesi

Bul, yaz.

Sinem markete gitti. Market arabasına içinde "s" harfi olan yiyecek ve içecekler koyacak.

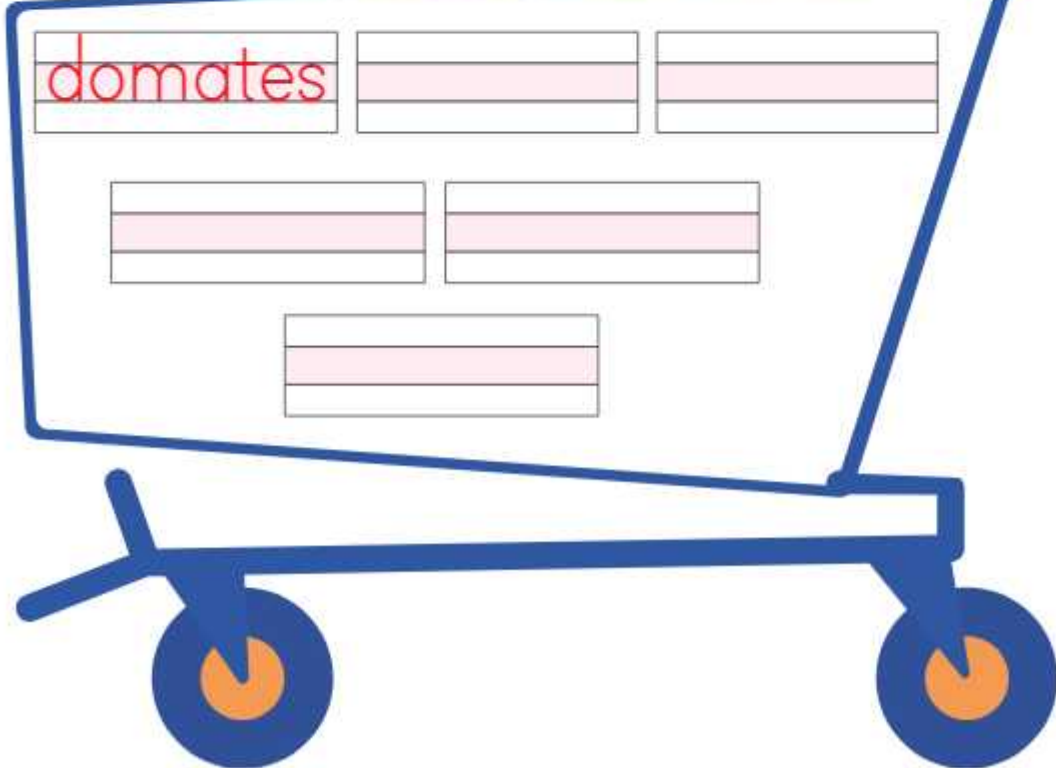



Etkinlik S, s Sesi

Oku, yaz.

1. Aslı sarı laleyi suladı.  
Aslı neyi suladı?

Aslı sarı laleyi suladı.



2. Selin simit yedi.  
Selin ne yedi?

3. Seda sek sek oynadı.  
Seda ne oynadı?

4. Annem sarımsak soydu.  
Annem ne soydu?

5. Selma ekmek kesti.  
Selma ne kesti?

6. Sinan okulu boyadı:  
Sinan neyi boyadı?



## 6.

## Etkinlik S, s Sesi Yaz.

- saksı
- asker
- masa
- kayısı
- salatalık
- sinek
- aslan
- süt
- saat
- simit

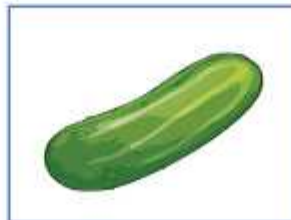

saksı





Etkinlik

S, s Sesi

Birleřtir, yaz.



Samet saat taktı.











Etkinlik B, b Sesi Yaz.



B B B B B B B B B B B B B

B B B B B B B

B B B B B B

B B B B

B B

B



Etkinlik B, b Sesi Yaz.

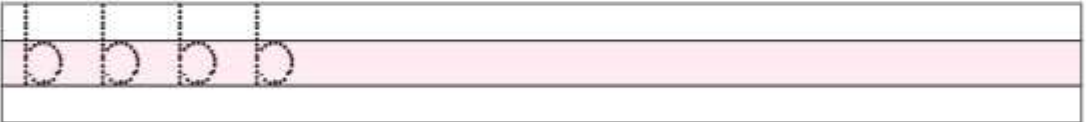
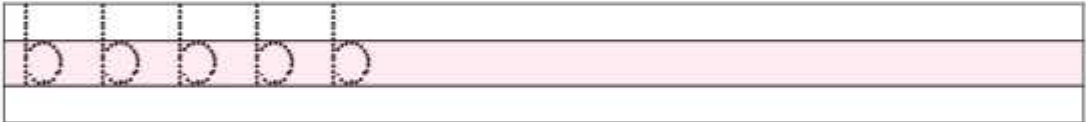
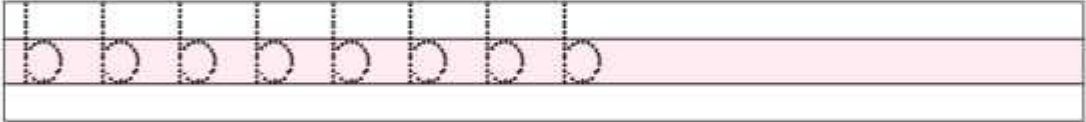
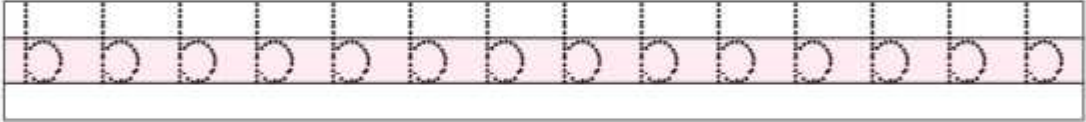



Etkinlik B, b Sesi Bak, anlat.



4.

Etkinlik B, b Sesi

Boya.

(İçinde "b" sesi olanı kırmızıya,  
"d" sesi olanı maviye)

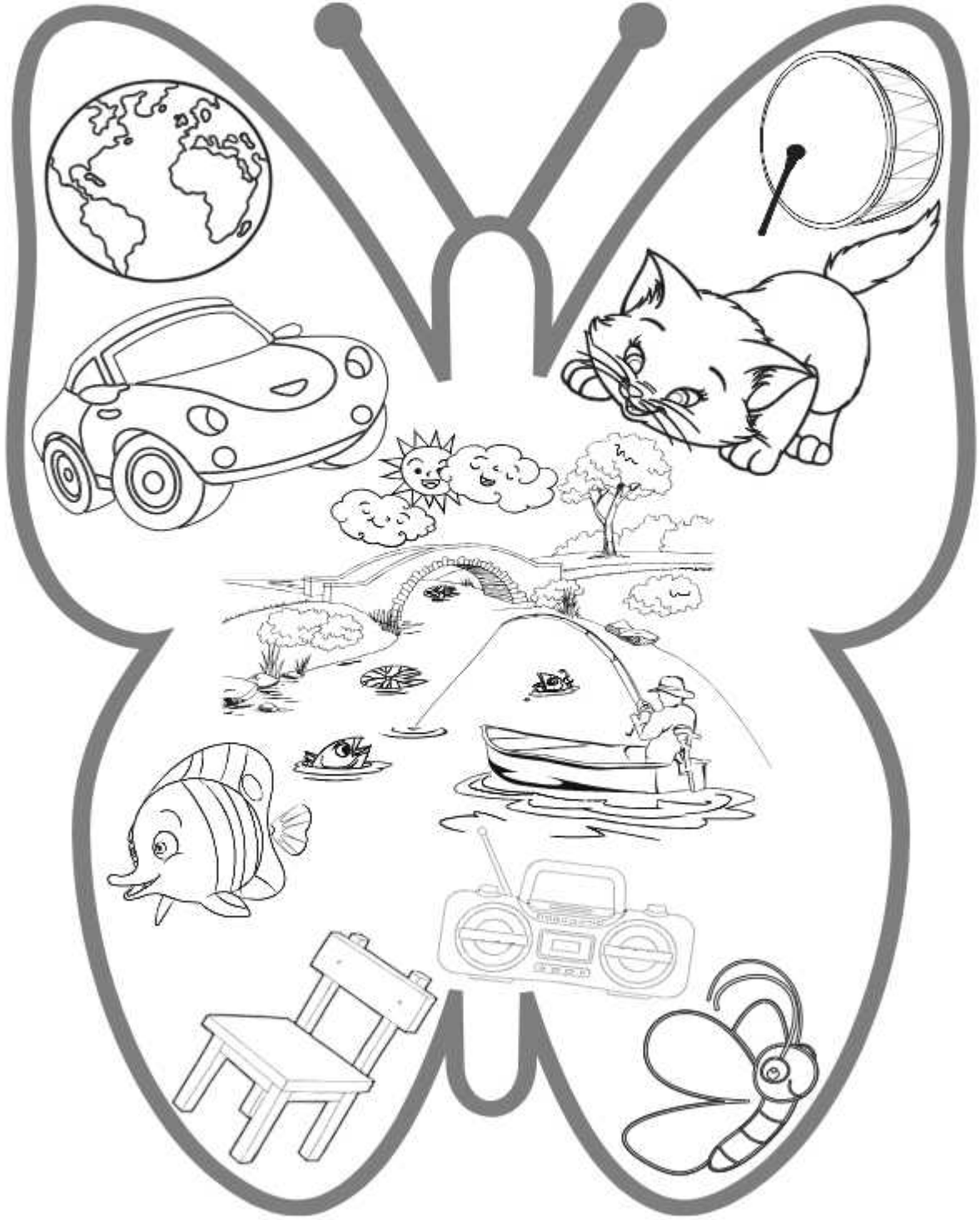

5.

Etkinlik B, b Sesi

Yaz, oku, eşle.

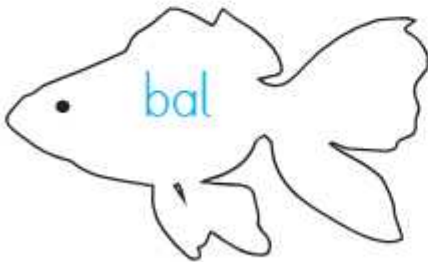
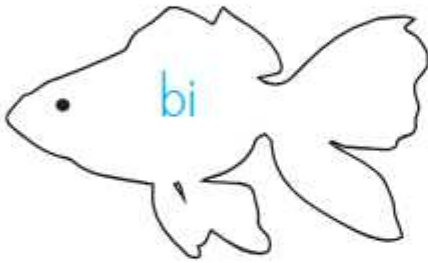
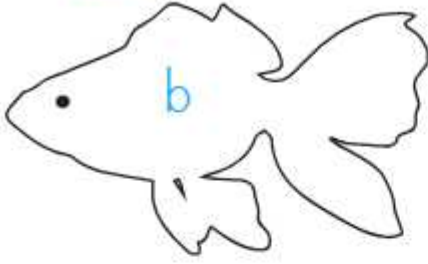



# 6. Etkinlik B, b Sesi

Kes, yapıştır  
(163. sayfaya).

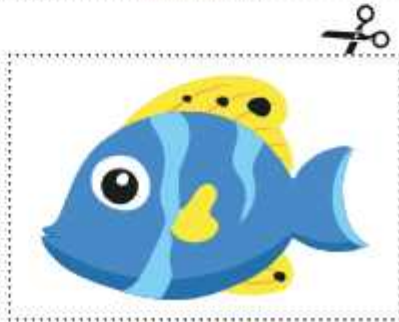
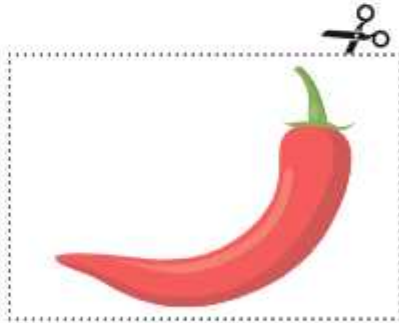
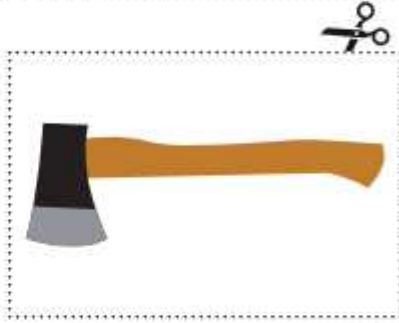

# 6. Etkinlik B, b Sesi



Etkinlik B, b Sesi

Oku, kes (161. sayfadan), yapıştır, yaz.

OKU

YAPIŞTIR

YAZ

balta

bebek

balon

biber

bilet



Etkinlik B, b Sesi

Oku, kes (161. sayfadan), yapıştır, yaz.

OKU

YAPIŞTIR

YAZ

börek

kabak

bulut

bayrak

balık



Etkinlik

B, b Sesi

Bul, boya.



|   |   |   |   |   |   |   |   |
|---|---|---|---|---|---|---|---|
| s | o | b | a | r | b | a | l |
| e | k | b | a | l | o | n | d |
| a | o | d | i | b | o | y | a |
| y | b | e | b | e | k | m | ü |
| n | l | o | t | o | b | ü | s |
| b | a | l | t | a | r | d | ı |
| s | b | r | a | i | ö | k | n |
| l | ö | b | a | l | ı | k | m |



Etkinlik

B, b Sesi

Oku, yaz, söyle.



## AİLEM

Benim tatlı ailem. Annem, babam ve ablam.  
Benim ailem birlikte mutludur. Babamın  
adı Birol. Babam büyük bir adam. Tatilde  
babam ve ben balon oynarız. Babam anneme  
bayramda kolye aldı. Annem mutlu oldu.



Etkinlik B, b Sesi

Oku, yaz, söyle.

1. Babamın adı nedir?

|  |
|--|
|  |
|  |
|  |

2. Babam benimle ne oynar?

|  |
|--|
|  |
|  |
|  |

3. Babam anneme ne aldı?

|  |
|--|
|  |
|  |
|  |

4. Sen de ailenin resmini çiz.

|  |
|--|
|  |
|--|



Etkinlik Z, z Sesi Yaz.

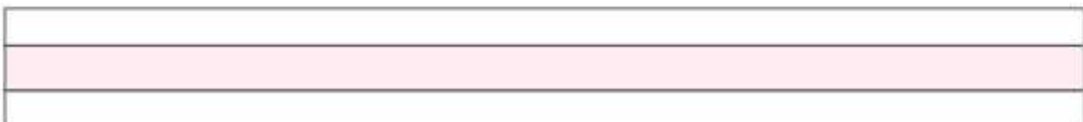
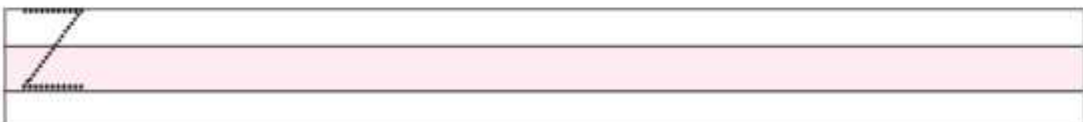
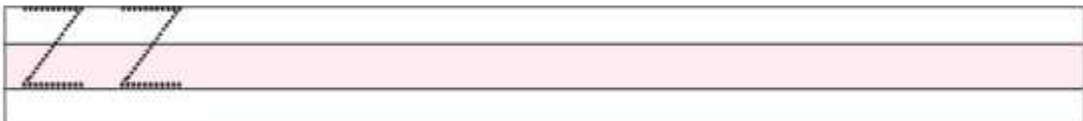
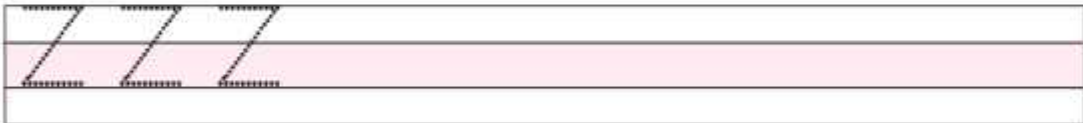
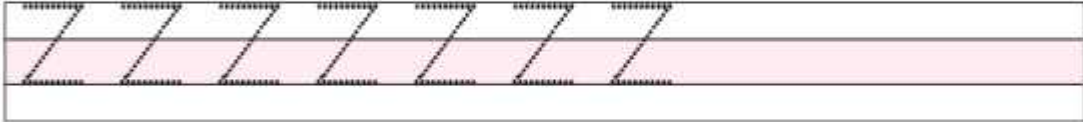
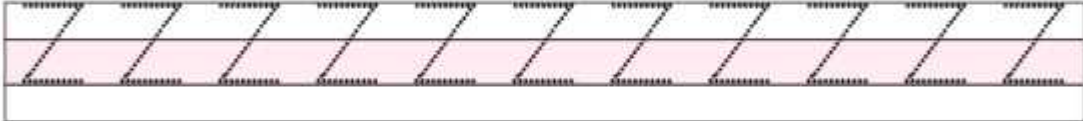





Etkinlik Z, z Sesi Yaz.



Handwriting practice lines for the letter 'Z'. Each line consists of a top and bottom boundary with a pink shaded middle area. The first line is filled with a repeating pattern of dashed 'Z' characters. The second line has a dashed 'Z' followed by a solid 'Z', with the rest of the line being blank. The third line has a dashed 'Z' followed by a solid 'Z', with the rest of the line being blank. The fourth line has a dashed 'Z' followed by a solid 'Z', with the rest of the line being blank. The fifth line has a dashed 'Z' followed by a solid 'Z', with the rest of the line being blank. The sixth line has a dashed 'Z' followed by a solid 'Z', with the rest of the line being blank. The seventh line is completely blank. The eighth line is completely blank.



Etkinlik

Z, z Sesi

Zebrayı çiz, boya.

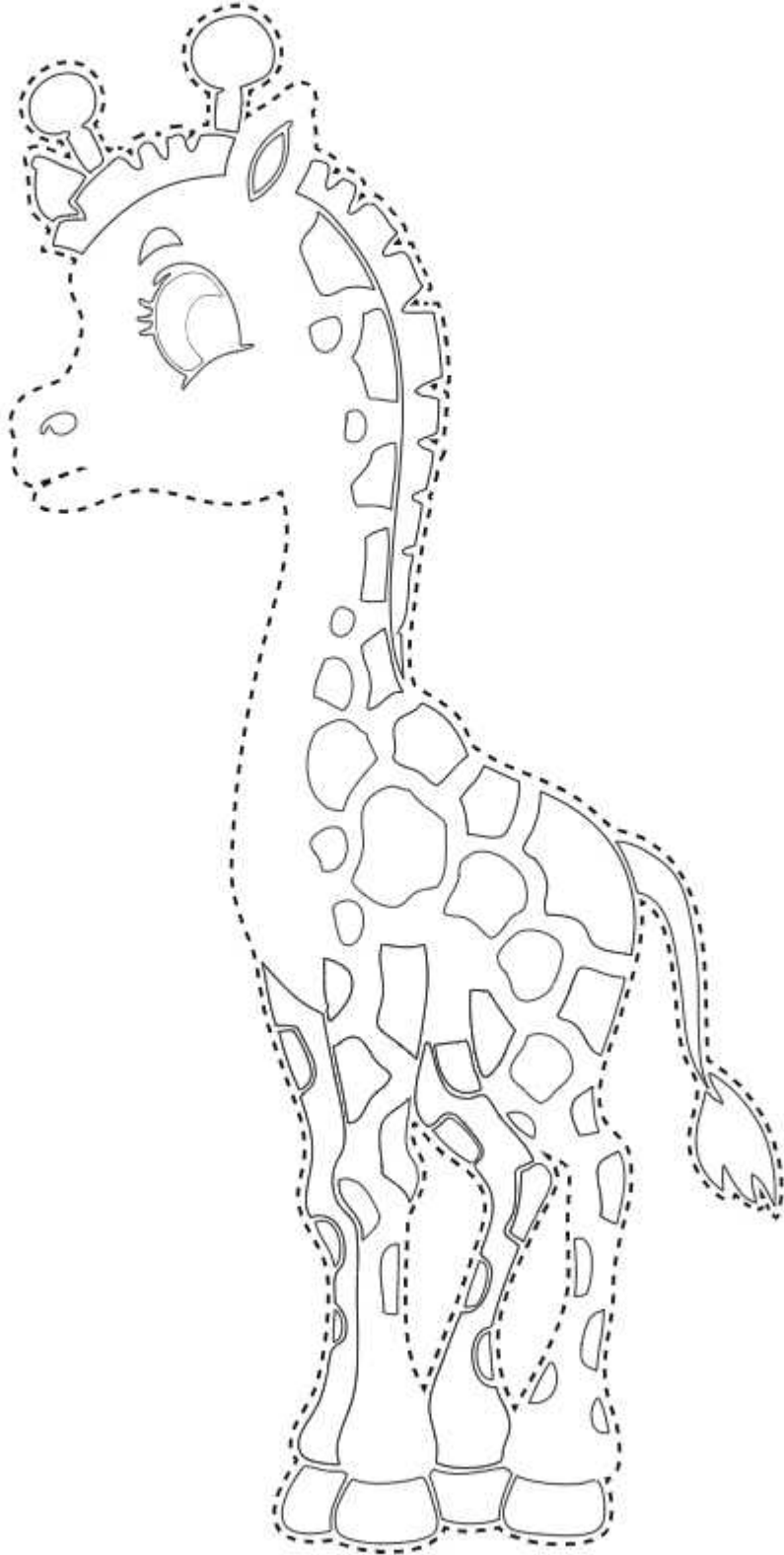

4

Etkinlik

Z, z Sesi

İşaretle (başta,  
sonda, ortada).

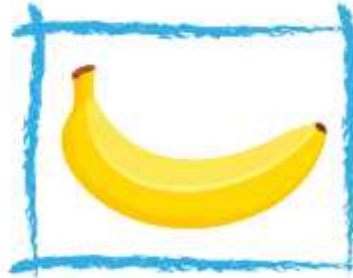

## 5.

## Etkinlik Z, z Sesi

Bak, anlat, numaralı kelimeleri yaz.



1.

5.

2.

6.

3.

7.

4.

8.





Etkinlik Z, z Sesi Bak, oku.



## YAZ MEVSİMİ

Ozan yaz mevsimini seviyor. Yaz tatilinde denize gitti. Tatilde Zerrin'i tanıdı. Ozan ile Zerrin beraber oynadı. Zerrin ile yüzdüler. Zeki onlara seslendi. Ozan ile Zerrin, Zeki'nin yanına geldi.



Etkinlik Z, z Sesi Oku, yaz.

|  |
|--|
|  |
|  |
|  |

|  |
|--|
|  |
|  |
|  |

|  |
|--|
|  |
|  |
|  |

|  |
|--|
|  |
|  |
|  |

|  |
|--|
|  |
|  |
|  |

|  |
|--|
|  |
|  |
|  |

|  |
|--|
|  |
|  |
|  |



Etkinlik Ç, ç Sesi Yaz.

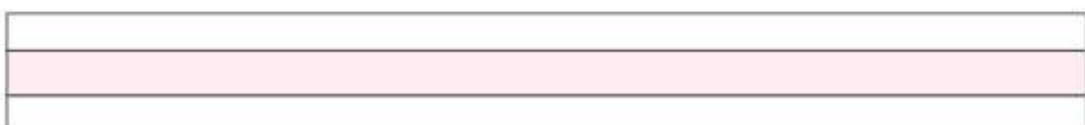
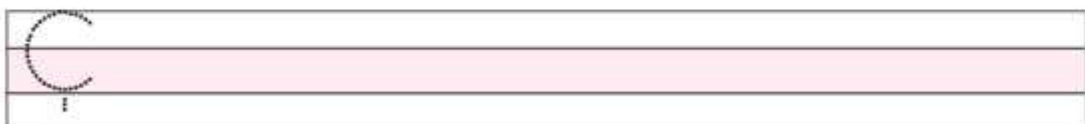
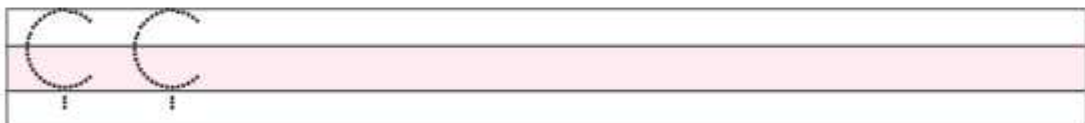
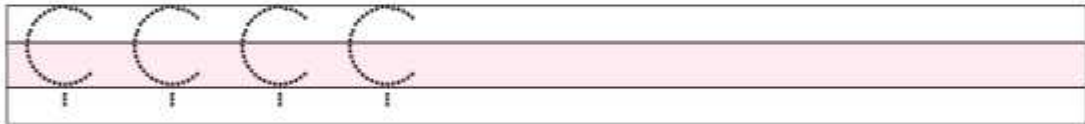
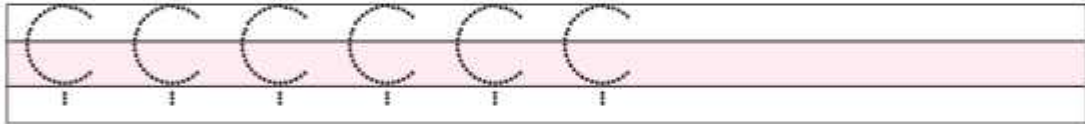
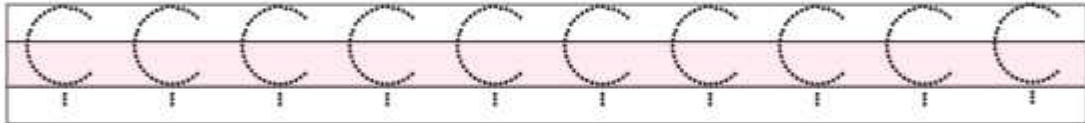





Etkinlik Ç, ç Sesi Yaz.

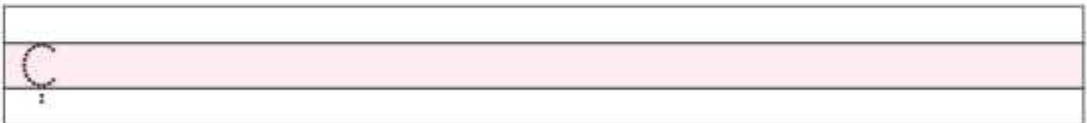
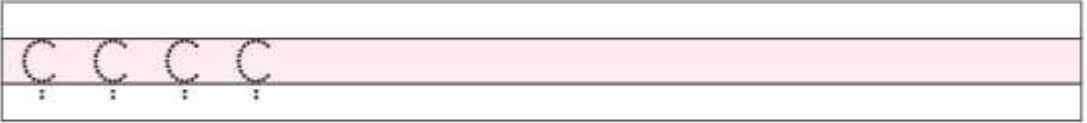
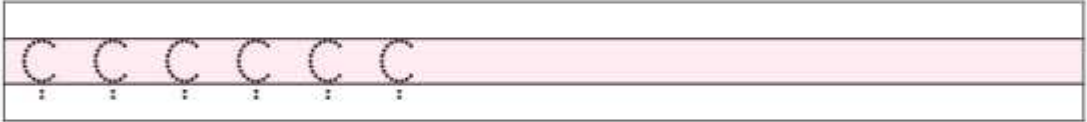
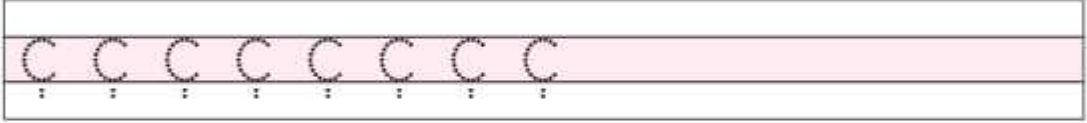
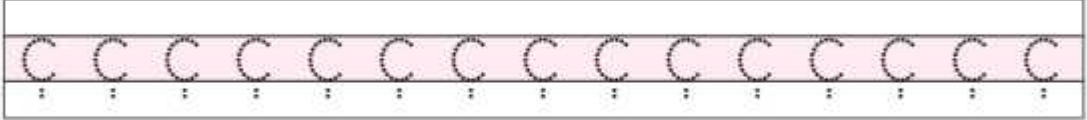









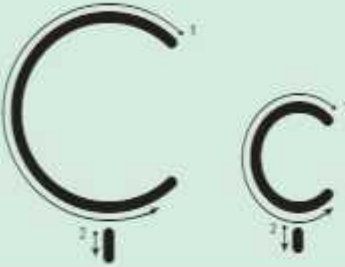
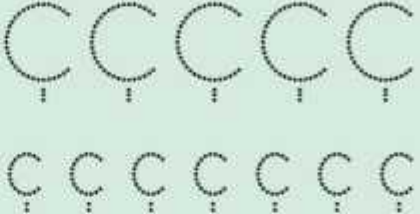

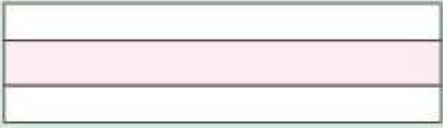
Etkinlik

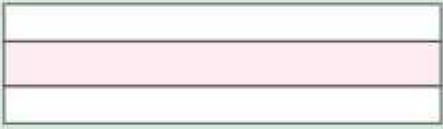
Ç, ç Sesi

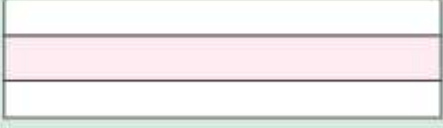
Yaz.

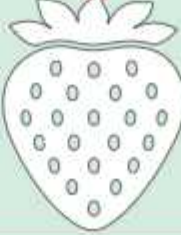
|  |  |
|--|--|
|                 | <p>Yaz</p>     |
|  <p>saç</p>     |                |
|  <p>çiçek</p> |              |
|  <p>üç</p>    |              |
|  <p>çilek</p> | <p>boya</p>  |

4

Etkinlik Ç, ç Sesi Bul, boya.

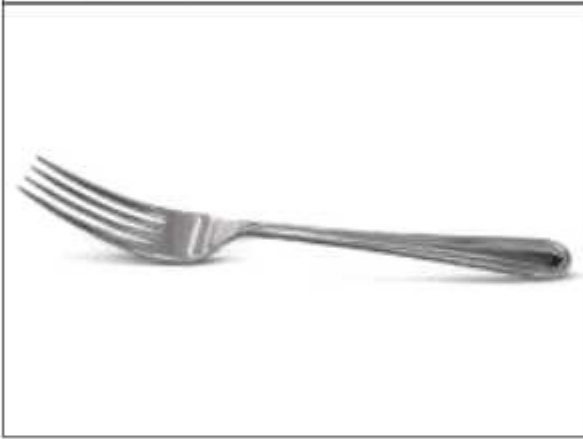

|   |   |   |   |   |   |   |
|---|---|---|---|---|---|---|
| Ç | İ | L | E | K | Ç | M |
| E | Ç | A | L | İ | D | N |
| Ö | T | Ç | A | T | A | L |
| Ç | A | N | T | A | O | S |

# 5.

## Etkinlik Ç, ç Sesi

Bak, oku, eşle.



Dinç çikolata yiyor.



Aytaç çay içiyor.



Serçe uçuyor.



Çilem çiçek suluyor.

# 6.

## Etkinlik Ç, ç Sesi Oku, yaz.



Üç uçak uçuyor.



Blank writing lines for the sentence: Burçin çorba içiyor.



Blank writing lines for the sentence: Annem çiçek dikeyor.



Blank writing lines for the sentence: Ümit çekic tutuyor.



Etkinlik 7. Ç, ç Sesi Oku.



Seçil bak, keçi.  
Tatlı, küçük keçi.  
Keçi süt istedi.  
Tunç sütü döktü.  
Küçük keçi üzüldü.  
Tunç keçiye süt aldı.  
Keçi sütü içti.



Etkinlik

Ç, ç Sesi

Bak, anlat, yaz.



1.

çam

3.

2.

4.

5.



Etkinlik G, g Sesi Yaz.

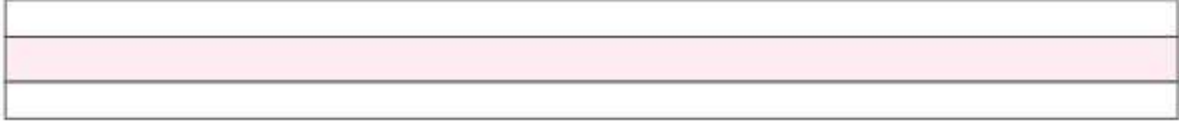
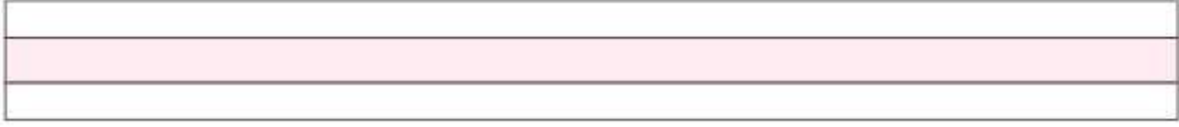
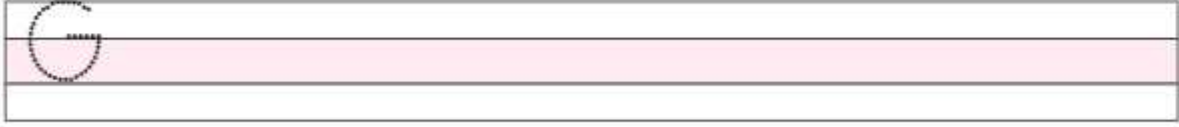
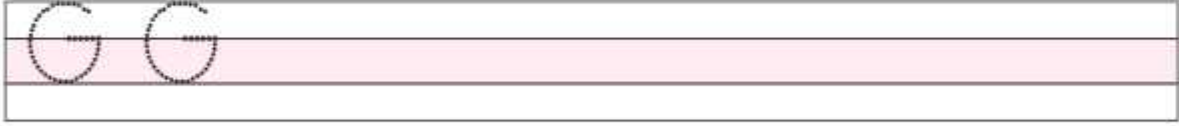
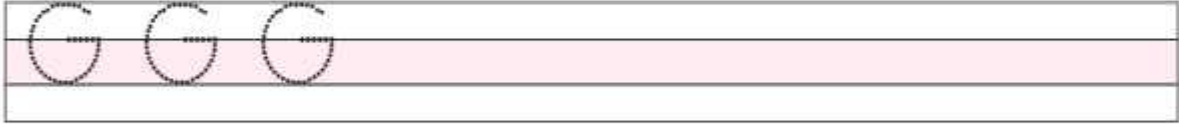
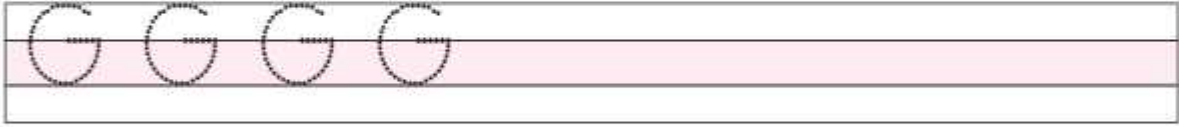
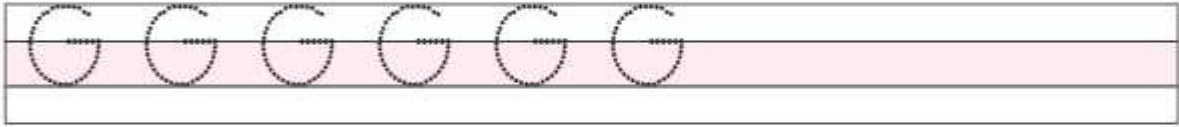
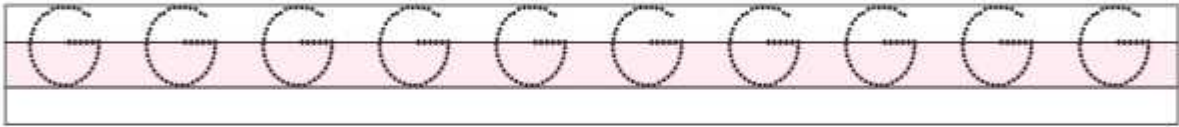





Etkinlik G, g Sesi Yaz.

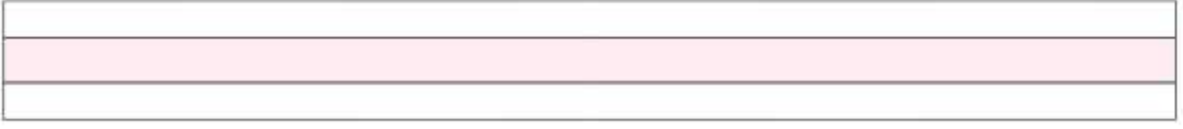
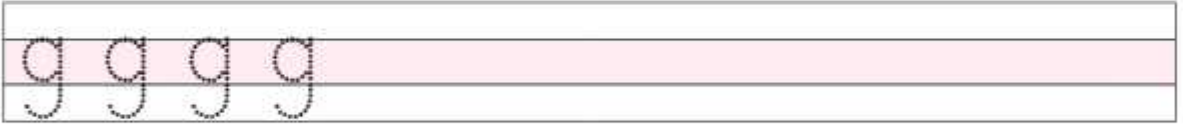
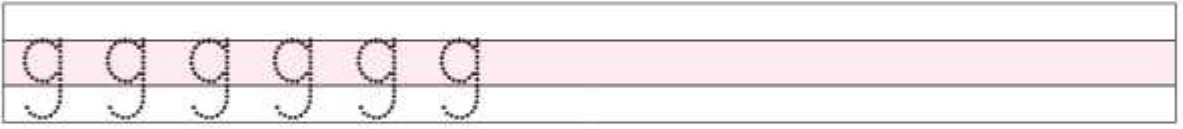
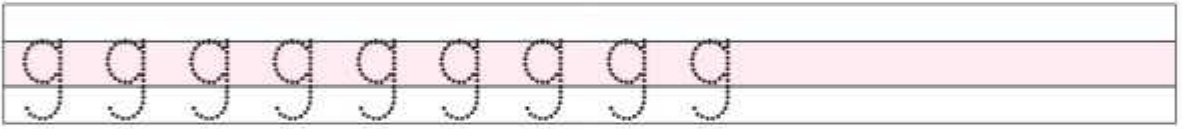
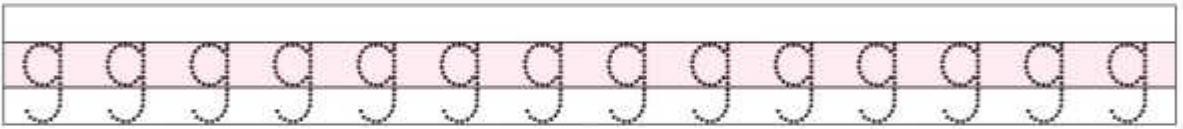



Etkinlik G, g Sesi

"G, g" sesini bul,  
işaretle.



## 4

## Etkinlik G, g Sesi Oku, yaz.

gergedan, silgi, geyik, üçgen, göz, gazete, karga,  
gitar, gömlek, gelin, gözlük, gül.



göz



5.

Etkinlik G, g Sesi

"g" sesli olanları  
bul, çiz, boya.

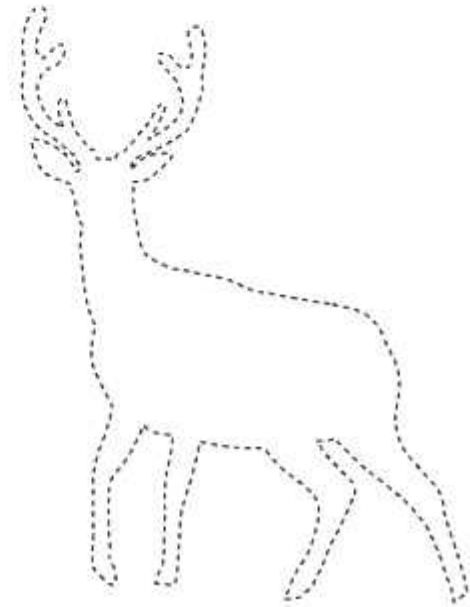
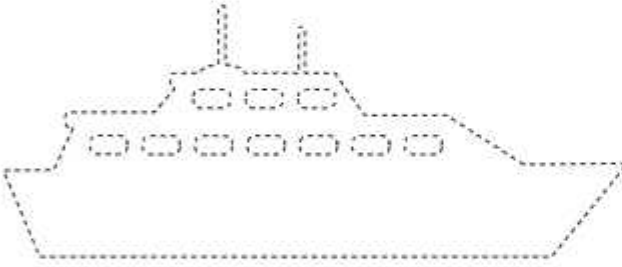
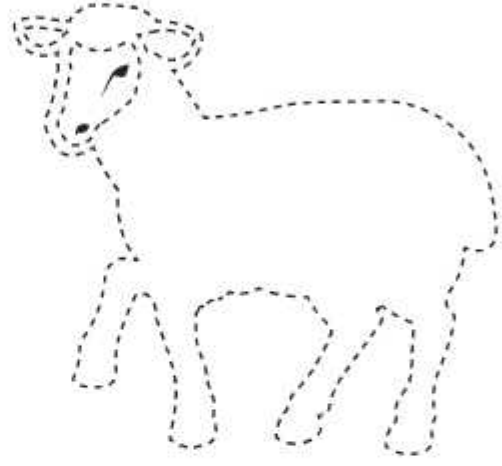
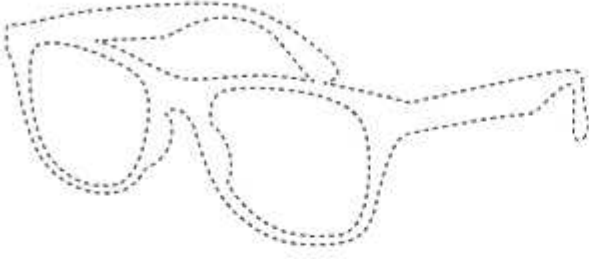

6. Etkinlik G, g Sesi Bak, anlat.





Etkinlik G, g Sesi Oku.



## GEMİ

Güzel güzel gemiler.  
Denizde göründüler.  
Dalgaların üstünde,  
Ne güzel yüzerler.  
Gemidekiler bize gülerler.  
Ne kadar da güzeller.



Etkinlik G, g Sesi Oku, bak, eşle.

Gamze annesine gül getirdi.



Gizem gitar çaldı.



Gergedan ile gorili gördük.



Nergis gazete okudu.



Ege gemi gördü.





Etkinlik G, g Sesi Oku, yaz.

## KARGA

Karga karga gak, dedi.

Çık o dala bak, dedi.

Çıktım, baktım o dala.

Bu karga ne ukala.

|  |
|--|
|  |
|  |
|  |

|  |
|--|
|  |
|  |
|  |

|  |
|--|
|  |
|  |
|  |

|  |
|--|
|  |
|  |
|  |

|  |
|--|
|  |
|  |
|  |





Etkinlik G, g Sesi Soruları cevapla.

Güngör gözüne gözlük taktı.

1. Güngör ne taktı?

|  |
|--|
|  |
|  |
|  |

2. Güngör nereye gözlük taktı?

|  |
|--|
|  |
|  |
|  |

Gemi dalgalı denizde yüzdü.

1. Denizde ne yüzdü?

|  |
|--|
|  |
|  |
|  |

2. Gemi nerede yüzdü?

|  |
|--|
|  |
|  |
|  |



Etkinlik

Ş, ş Sesi

Yaz.

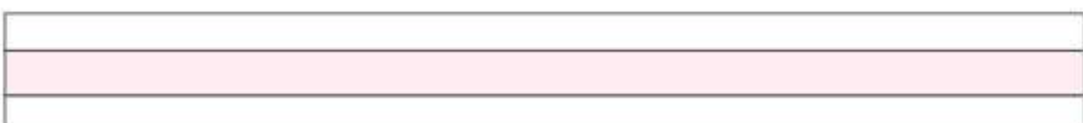
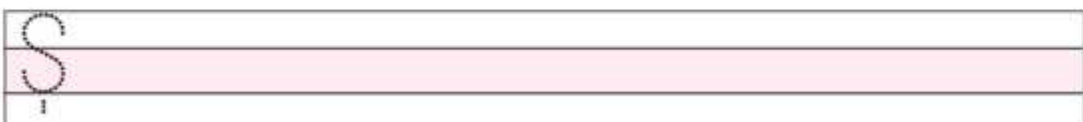
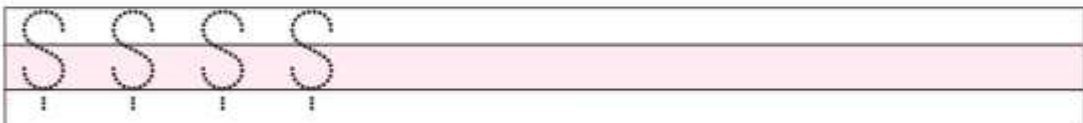
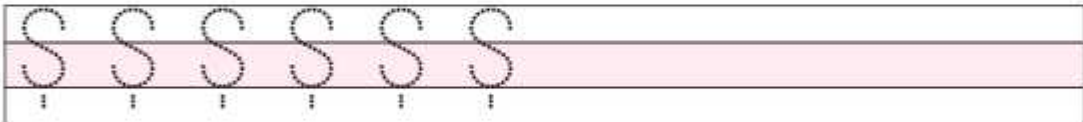
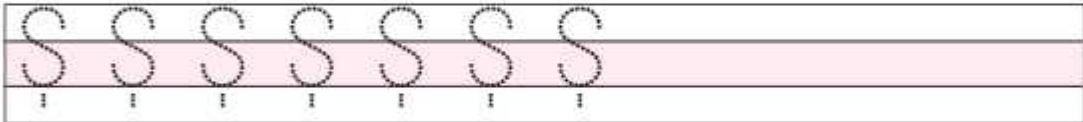
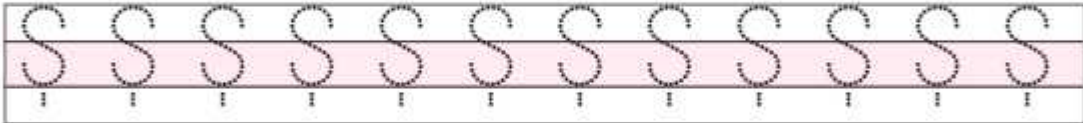



Etkinlik Ş, ş Sesi Yaz.

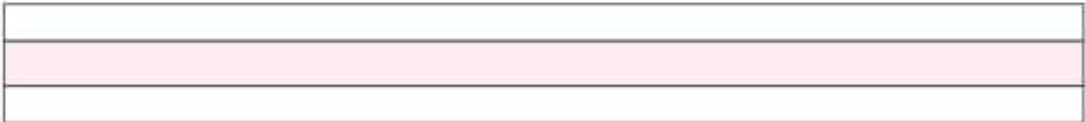
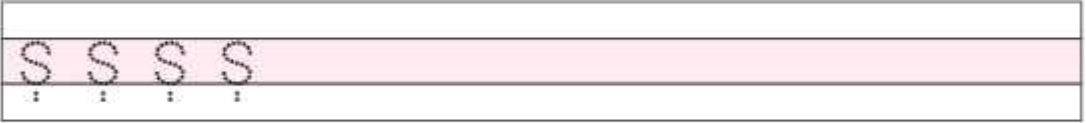
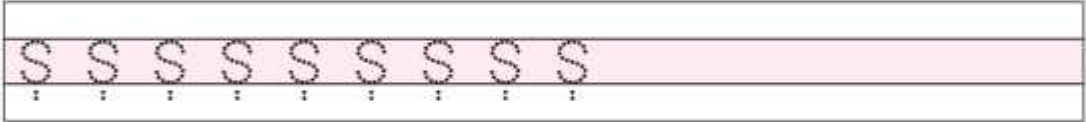
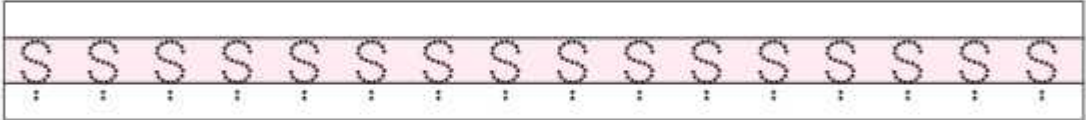

## 3

## Etkinlik Ş, ş Sesi Oku, yaz.

kuş, şeker, güneş, boş kutu, kaşık, taş,  
şelale, diş, şort, şemsiye, akşam, şişe.



şemsiye



## 4

## Etkinlik

## Ş, ş Sesi

Bak, oku, yaz, eşle.



Şule şemsiye aldı.



Başak, dişin çürümüş.



Şükrü arkadaşıyla konuşuyor.



Barış eşekten düştü.



Aşkın akşam erken yattı.

5.

Etkinlik

Ş, ş Sesi

Bak, oku, yaz, eşle.



Araba yeşil ışıpta geçti.

Şişe masadan düştü.

Şelale şırl şırl akıyor.

Şermin yağmurda şemsiye açtı.

Şener okulda düştü.

## 6.

## Etkinlik

## Ş, ş Sesi

Bulmacayı çöz.

AŞI, ŞEKER, KAŞIK, KİŞ, MAŞA, YEŞİL, EŞEK,  
GÜNEŞ, DİŞ, BEŞ, ŞEMSİYE, AKŞAM, KUŞ, IŞIK,

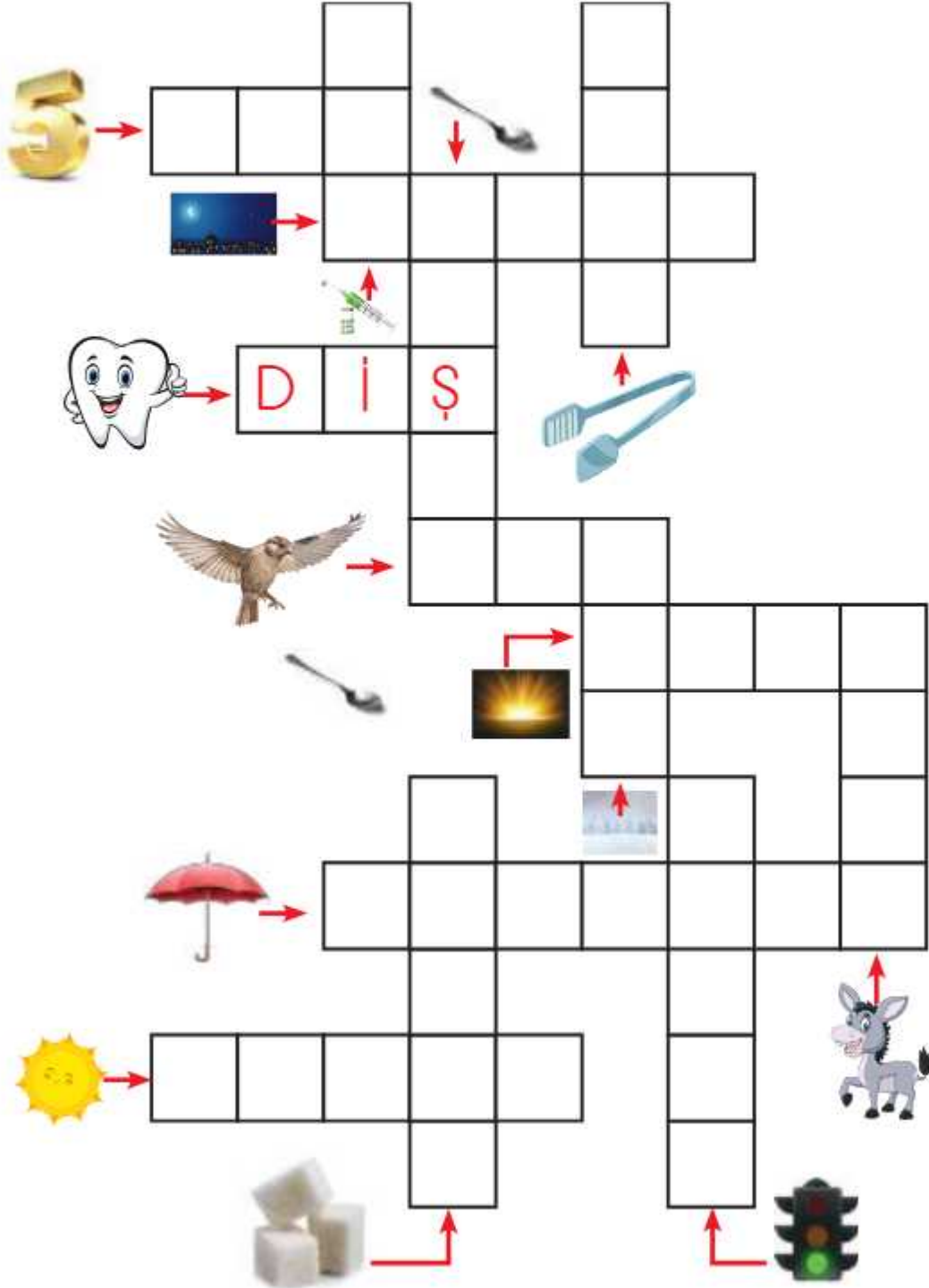







Etkinlik Ş, ş Sesi

GÜZEL BİR GÜN  
adlı metnin resmini çiz.

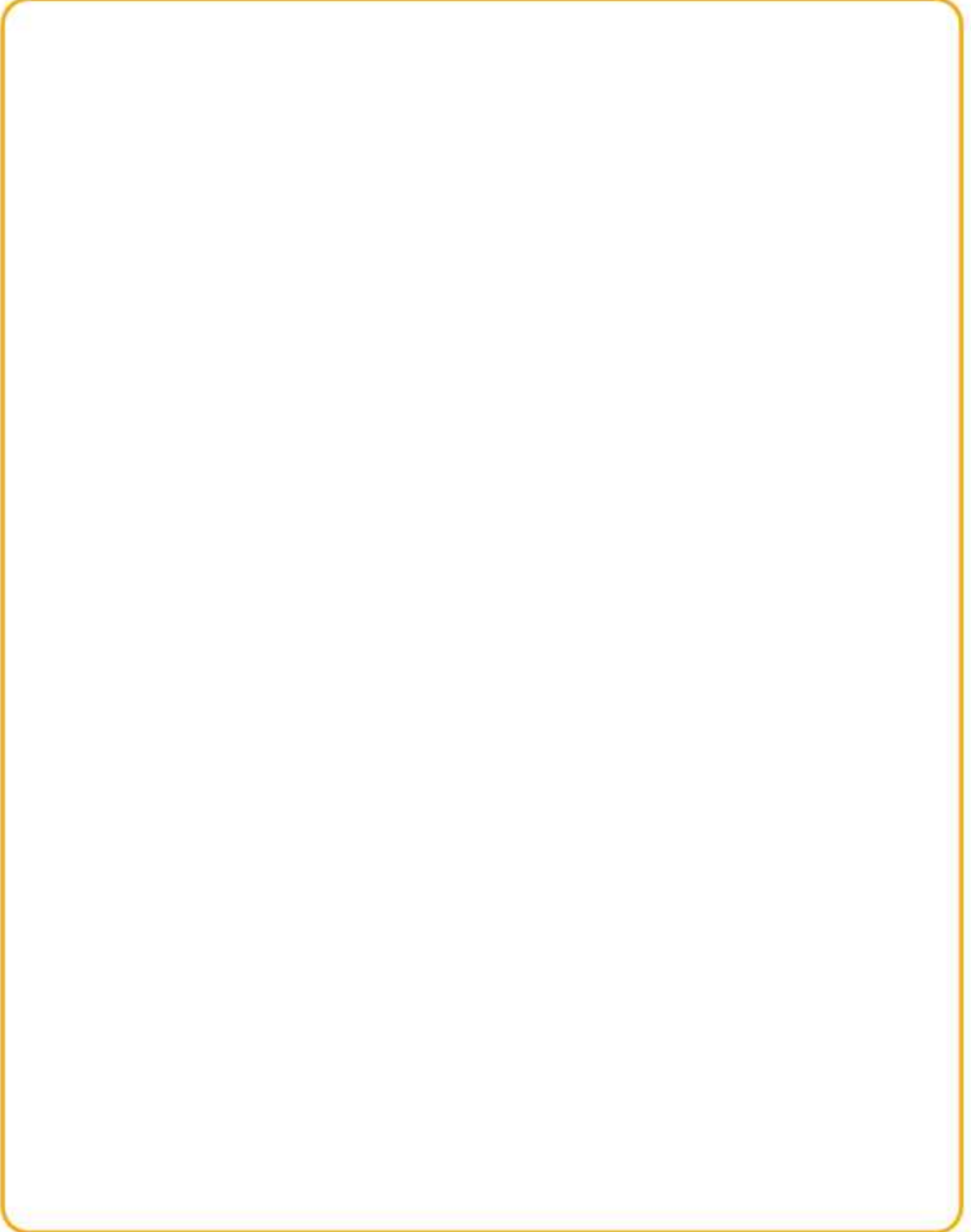





Etkinlik C, c Sesi Yaz.

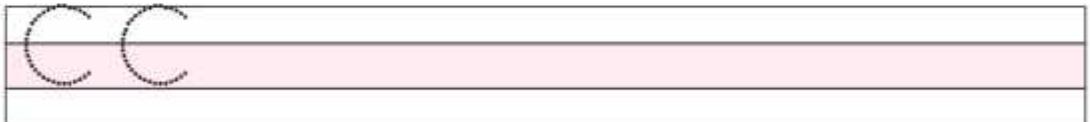
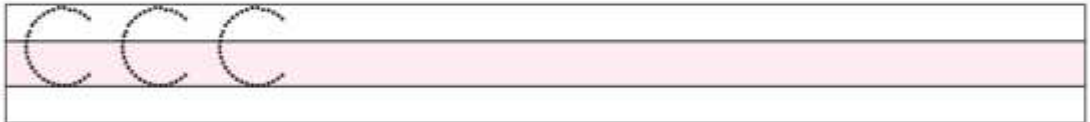
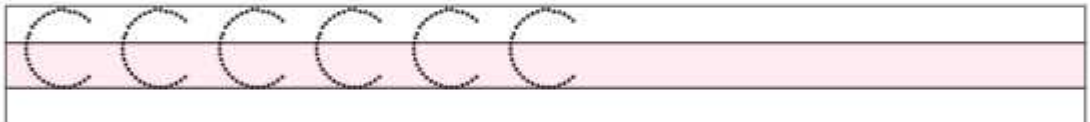
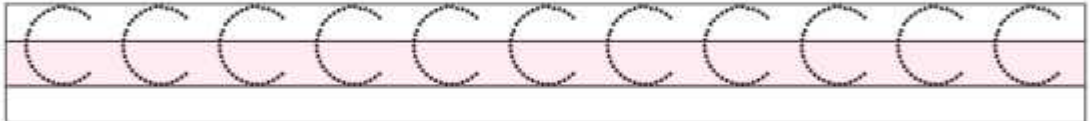

2.

Etkinlik C, c Sesi Yaz.



C C C C C C C C C C C C C C

C C C C C C C C

C C C C C C

C C C C

C C

C



Etkinlik

C, c Sesi

Bul, boya.

baca



boncuk



oyuncak



cam



sucuk



inci



Canan



örümcek



yonca



ceket



|   |   |   |   |   |   |   |   |   |   |   |
|---|---|---|---|---|---|---|---|---|---|---|
| R | I | Ö | R | Ü | M | C | E | K | N | L |
| İ | S | U | C | U | K | Y | Ü | B | İ | E |
| N | D | S | E | B | A | C | A | O | K | C |
| C | A | M | K | Z | M | U | T | N | L | A |
| İ | Ç | Ş | E | K | Y | O | N | C | A | N |
| B | E | G | T | O | T | E | N | U | L | A |
| O | Y | U | N | C | A | K | E | K | Ş | N |



5.

Etkinlik C, c Sesi

Bul, kes, birleştir, yapıştır  
(209. sayfaya).



# 5 Etkinlik C, c Sesi



5.

Etkinlik Y, y Sesi

Bul, kes (207. sayfadan),  
birleştir, yapıştır.



6.

Etkinlik

C, c Sesi

Seç, anlat.

1



3

2



4



Etkinlik C, c Sesi

Kaplumbağayı  
denize ulaştır.

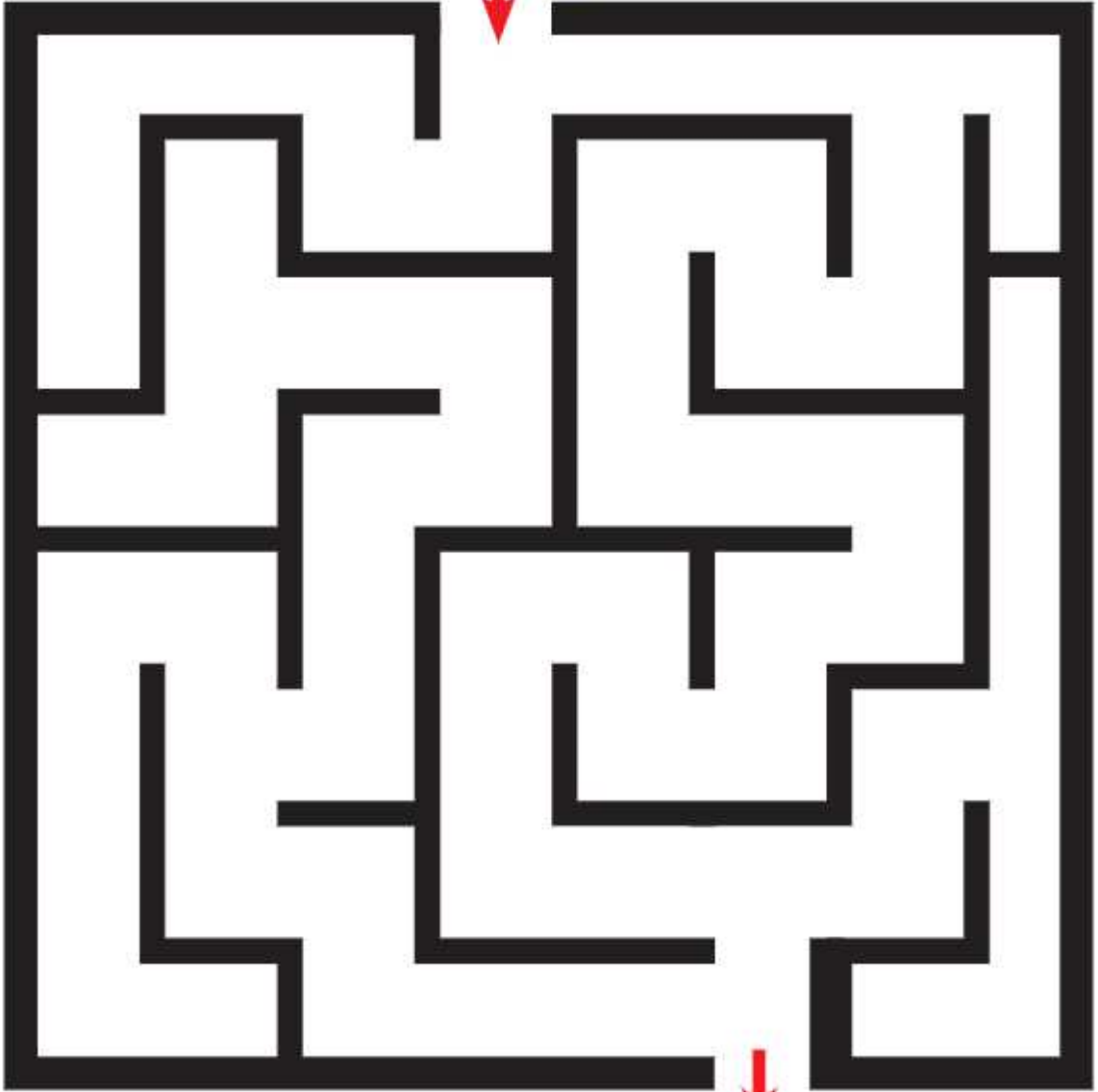



Etkinlik C, c Sesi Bul, yaz.

k e t e c



ceket



y o n u k c a



Blank writing box with a pink highlight.



k u s u c



Blank writing box with a pink highlight.



i r n c i



Blank writing box with a pink highlight.



c a n o y



Blank writing box with a pink highlight.





Etkinlik C, c Sesi Bul, yaz.

k u c b n o



a c m



n i c i



r ü k c e ö m



c a b a





Etkinlik

C, c Sesi

Bul, yaz, eşle.

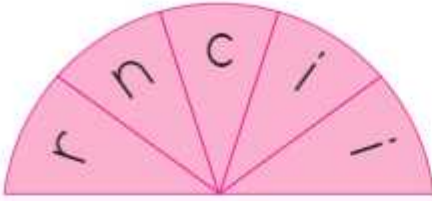

incir

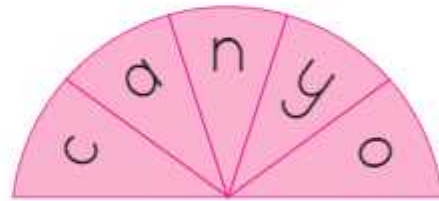
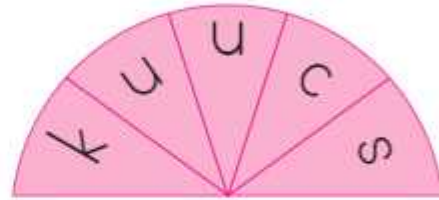
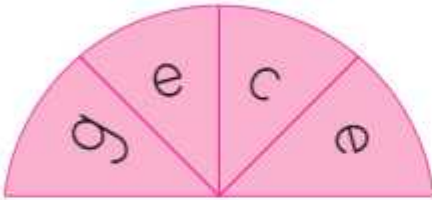
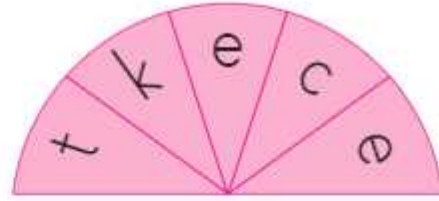



Etkinlik P, p Sesi Yaz.

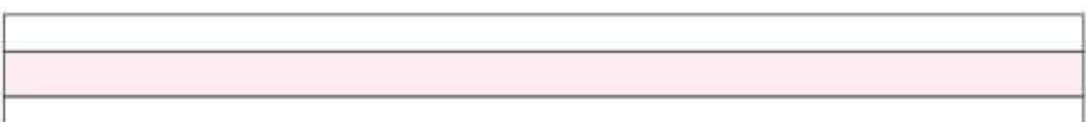
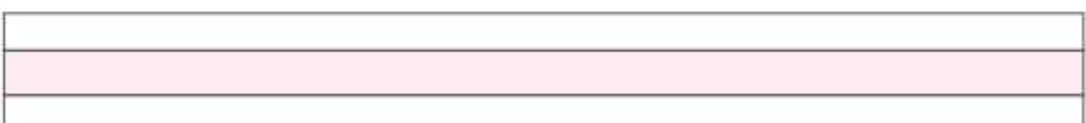
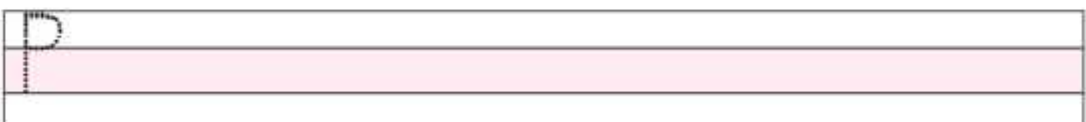
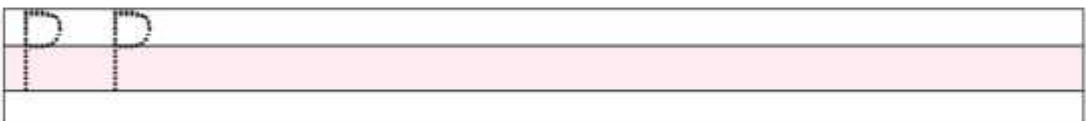
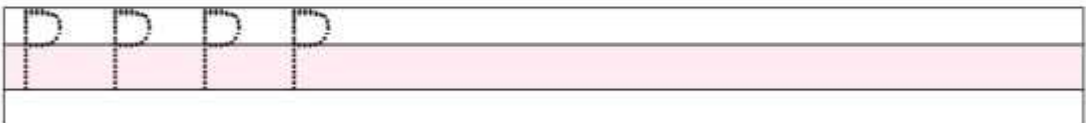
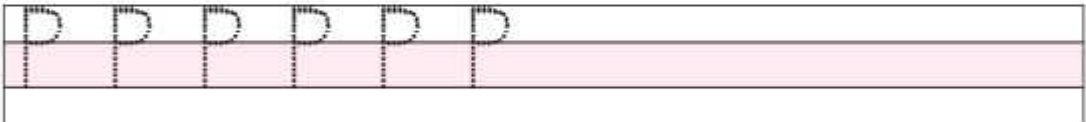
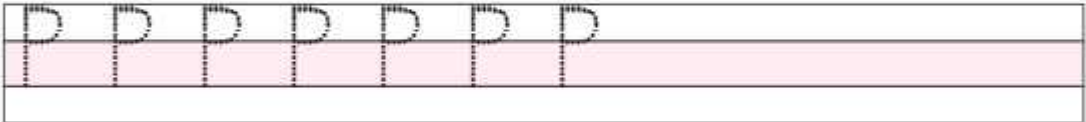



Etkinlik P, p Sesi Yaz.

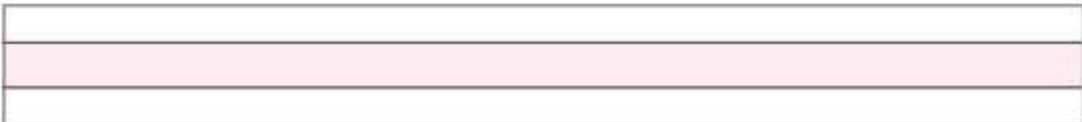
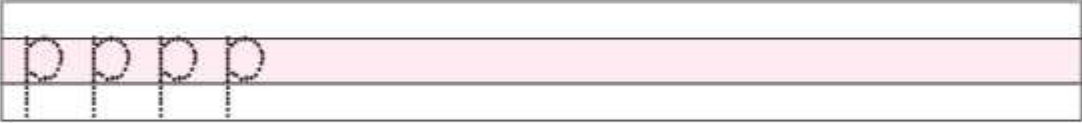
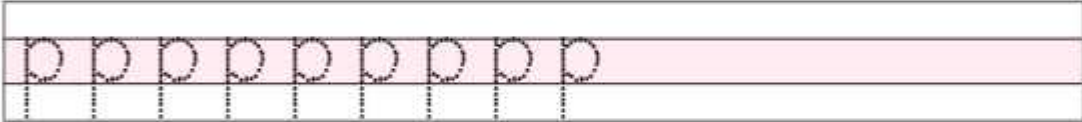
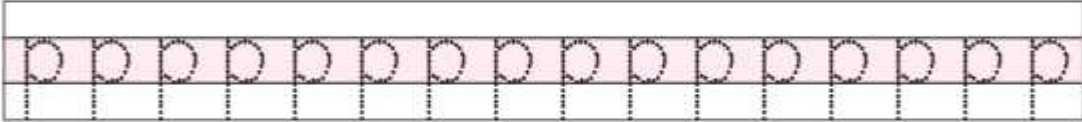
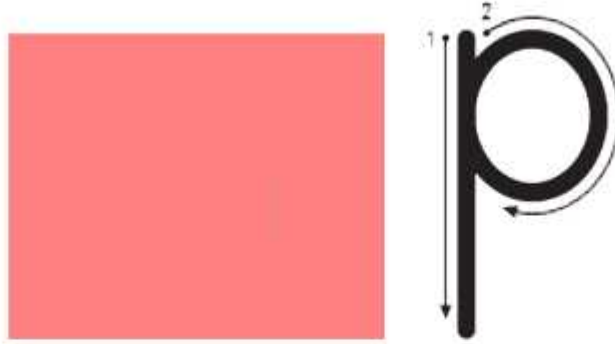





Etkinlik

P, p Sesi

Oku, iřaretle.

Alper papatya toplu.



Serpil, patates piřti.



Pelin kapıyı kapat.



Pınar top oyna.



Polat o piyano.



## 4

## Etkinlik P, p Sesi

Bul, boya.

1. PAPATYA



6. TÜP



2. PİL



7. POTA



3. PİLOT



8. PİKNIK



4. İP



9. PEYNİR



5. KAPI



10. PİRİNÇ



11. ŞAPKA



|   |   |   |   |   |   |   |   |   |
|---|---|---|---|---|---|---|---|---|
| A | E | K | A | P | I | O | M | N |
| Ö | R | I | P | E | Y | N | İ | R |
| M | P | İ | L | O | G | İ | P | Ş |
| Ş | G | Ş | D | P | İ | L | O | T |
| A | P | A | P | A | T | Y | A | Z |
| P | Ç | P | İ | R | İ | N | Ç | E |
| K | T | Ü | P | O | T | A | İ | L |
| A | Z | P | İ | K | N | İ | K | S |

5.

Etkinlik P, p Sesi Bulmacayı çözü.

TOP

PEMBE

PEÇETE

PAMUK

PANTOLON

KUPA

KİTAP

PİYANO

KARPUZ

ŞURUP

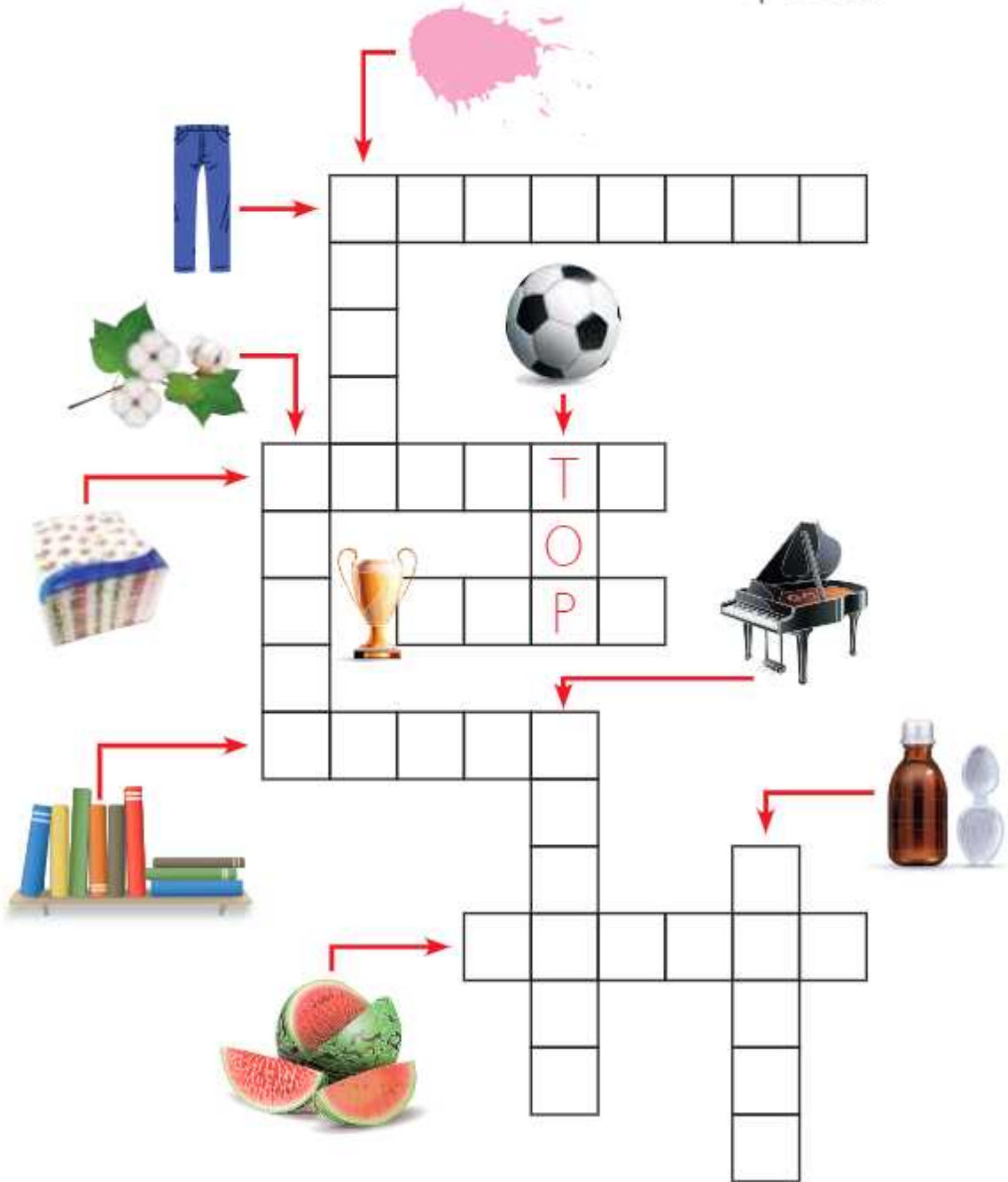

# 6.

## Etkinlik

### P, p Sesi

Bul, yaz.

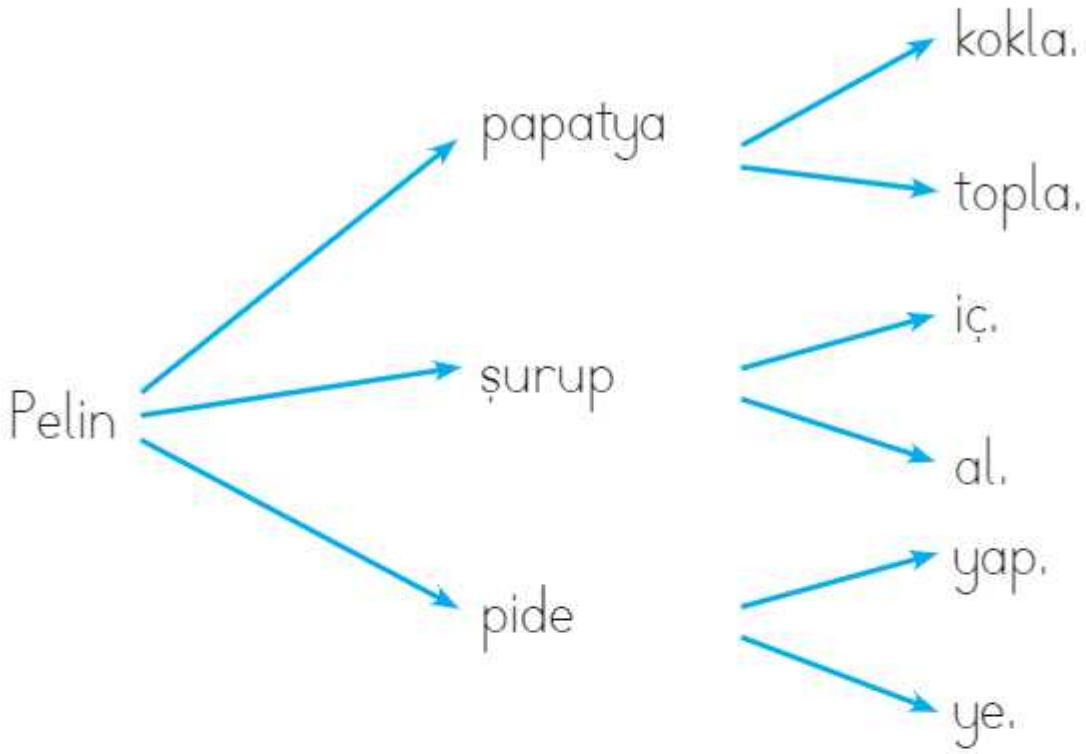

|  |
|--|
|  |
|  |
|  |
|  |
|  |
|  |



|  |
|--|
|  |
|  |
|  |
|  |
|  |
|  |



|  |
|--|
|  |
|  |
|  |
|  |
|  |
|  |

# 7.

Etkinlik P, p Sesi Bak, anlat, yaz.



1.

2.

3.

4.

5.

6.



Etkinlik

P, p Sesi

Bul, say, yaz.

köpek

kirpi

kirpi

kirpi

sepet

köpek

pide

çorap

sepet

köpek

pide

para

Pınar

sepet

pide

para



1





## PARK

Pelin ile İpek, parka gittiler.

Parkta salıncakta sallandılar.

Birlikte ip atladılar.

Arkadaşları ile top aynadılar.

Koşup papatya topladılar.

Parkta piknik yaptılar.

Sonra çöpleri topladılar.





2.

Etkinlik H, h Sesi Yaz.



Handwriting practice lines for the letter 'h'. Each line consists of a top line, a middle line, and a bottom line. The first line contains 15 dashed 'h' characters for tracing. The second line contains 8 dashed 'h' characters for tracing, followed by a blank space. The third line contains 5 dashed 'h' characters for tracing, followed by a blank space. The fourth line contains 3 dashed 'h' characters for tracing, followed by a blank space. The fifth line contains 2 dashed 'h' characters for tracing, followed by a blank space. The sixth line contains 1 dashed 'h' character for tracing, followed by a blank space. The seventh and eighth lines are completely blank for independent practice.

3

Etkinlik

H, h Sesi

Bak, canlandır,  
anlat.



4.

Etkinlik H, h Sesi

Bul, kes, birleştir, yapıştır  
(229. sayfaya).



# 4 Etkinlik H, h Sesi

4

Etkinlik H, h Sesi

Bul, kes (227. sayfadan),  
birleştir, yapıştır.



## 5.

Etkinlik H, h Sesi Oku, yaz.

Hülya 2  dondurma ye.

kühah

Hande  da  var.Hazal  ye.Hale  öttü.Tahir  resmi çiz.

## 6.

Etkinlik H, h Sesi Bul, yaz.

ANAHTAR

HASTANE

SEHPA

HİNDİ

BAHÇE

HAMSI

HİLAL

HEMŞİRE

ANAHTAR

HİNDİ

HİLAL

HASTANE

BAHÇE

HEMŞİRE

SEHPA

HAMSI



Etkinlik V, v Sesi Yaz.

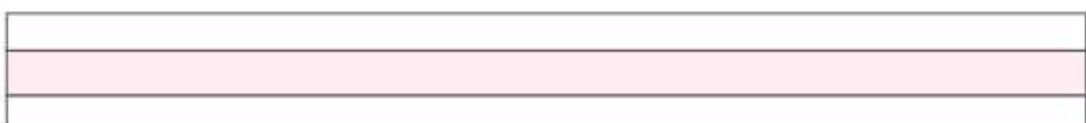
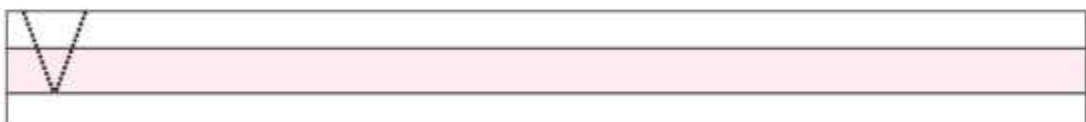
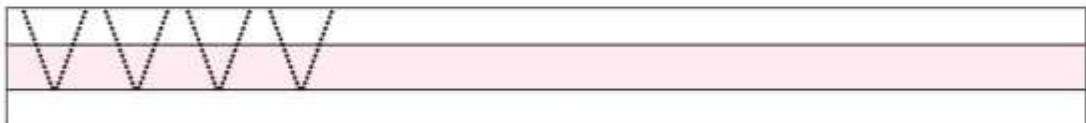
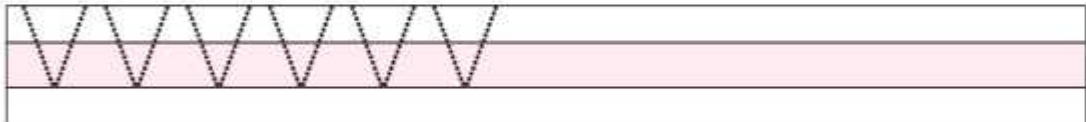
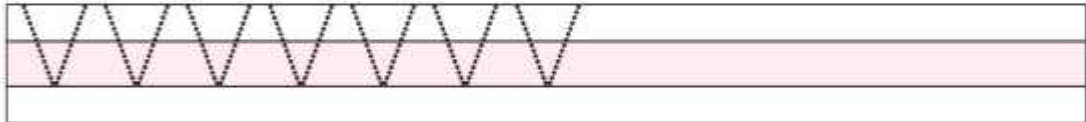
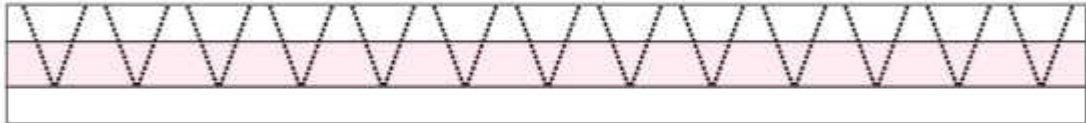



2.

Etkinlik V, v Sesi Yaz.















Handwriting practice lines for the letter V. Each line consists of a top white line, a middle pink line, and a bottom white line. The first line contains 12 dashed uppercase V's for tracing. The second line contains 7 dashed uppercase V's. The third line contains 5 dashed uppercase V's. The fourth line contains 3 dashed uppercase V's. The fifth line contains 2 dashed uppercase V's. The sixth line contains 1 dashed uppercase V. The remaining four lines are blank for independent practice.



Etkinlik V, v Sesi

Bul, yaz.

|   |   |   |  |
|---|---|---|--|
| a   | e   | h   | k  |
|    |    |    |    |
| l   | m   | u   | ü  |
|    |    |    |    |
| r   | s   | t   | p  |
|  |  |  |  |





Etkinlik V, v Sesi

Bul, boya.

1. KOVA



7. DUVAR



2. DEVE



8. OKLAVA



3. AYVA



9. ÇİVİ



4. KAVUN



10. ÇUVAL



5. KİVİ



11. BAKLAVA



6. DAVUL



12. TAKVİM



|   |   |   |   |   |   |   |   |   |   |   |
|---|---|---|---|---|---|---|---|---|---|---|
| B | A | K | L | A | V | A | D | E | V | E |
| A | T | D | Ç | K | Ç | N | O | V | A | T |
| Ç | A | U | U | K | U | A | K | K | L | V |
| İ | K | V | L | O | V | U | L | İ | U | B |
| V | V | A | Y | V | A | D | A | V | U | L |
| İ | İ | R | E | A | L | V | V | İ | K | D |
| V | M | V | A | L | E | K | A | V | U | N |

5.

Etkinlik V, v Sesi Oku.



Veysel denizde yüzüyor.



Nevin ceviz yiyor.



Etkinlik V, v Sesi Oku, bul.

Vildan kavunu çok sever.

|  |
|--|
|  |
|  |
|  |

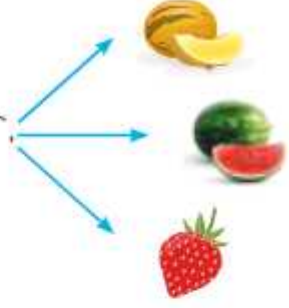

Vedat kivi yedi.

|  |
|--|
|  |
|  |
|  |



Veysel vazo kırıldı.

|  |
|--|
|  |
|  |
|  |



Nevin havlu ıslak.

|  |
|--|
|  |
|  |
|  |



Veli o davul.

|  |
|--|
|  |
|  |
|  |





Etkinlik V, v Sesi

Oku, yaz.



arıların evidir.

Kovan arıların evidir.

Veli eve



almış.

Blank writing lines for the sentence: Veli eve almış.

Vedat



çaldı.

Blank writing lines for the sentence: Vedat çaldı.

Yaman



yedi.

Blank writing lines for the sentence: Yaman yedi.

Tavşan



sever.

Blank writing lines for the sentence: Tavşan sever.



Etkinlik

V, v Sesi

Oku, yaz.

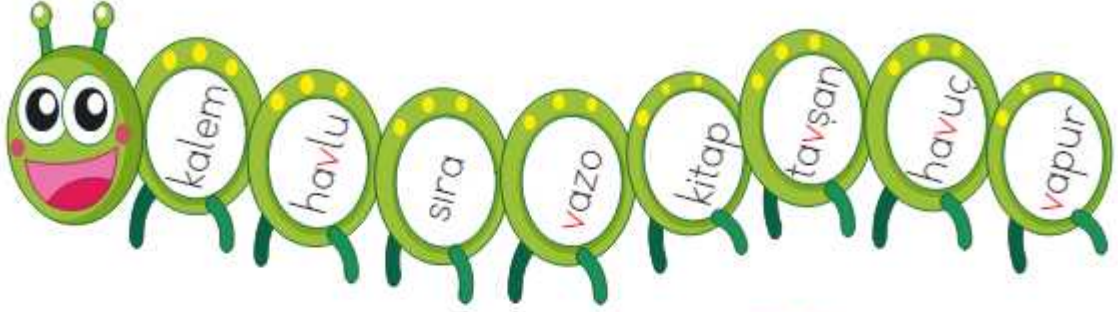

|  |
|--|
|  |
|  |
|  |



|  |
|--|
|  |
|  |
|  |



|  |
|--|
|  |
|  |
|  |



|  |
|--|
|  |
|  |
|  |



|  |
|--|
|  |
|  |
|  |



Etkinlik Ğ, ğ Sesi Yaz.



Ğ Ğ Ğ Ğ Ğ Ğ Ğ Ğ Ğ Ğ Ğ Ğ Ğ Ğ

Ğ Ğ Ğ Ğ Ğ Ğ Ğ

Ğ Ğ Ğ Ğ Ğ

Ğ Ğ Ğ

Ğ Ğ

Ğ



2.

Etkinlik Ğ, ğ Sesi Yaz.



ğ ğ ğ ğ ğ ğ ğ ğ ğ ğ ğ ğ ğ ğ

ğ ğ ğ ğ ğ ğ ğ ğ

ğ ğ ğ ğ ğ

ğ ğ ğ

ğ ğ

ğ

# 3

Etkinlik) Ğ, ğ Sesi Bul, yaz, oku.

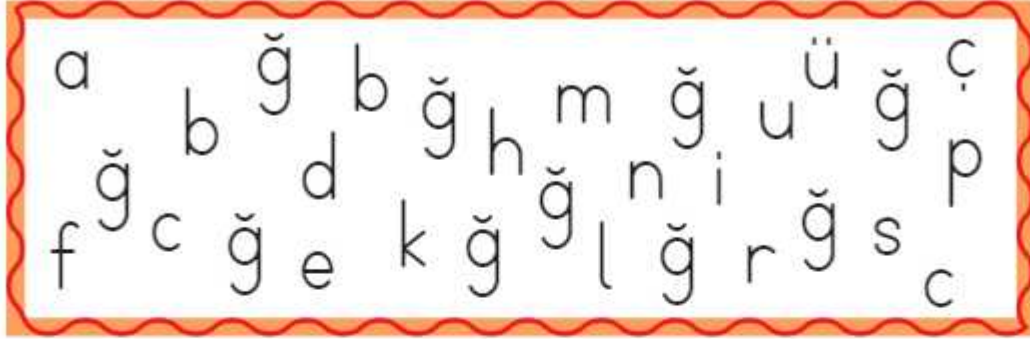

yağmur



ö\_renci



kurba\_a



tu\_la



i\_ne



ayçiçe\_i



kaplumba\_a



papa\_an



ö\_retmen

## 4

Etkinlik Ğ, ğ Sesi Bul, kes, yapıştır, yaz.



yağmur

















düğme ✂

dağ ✂

soğan ✂

ağız ✂

ağaç ✂

yağmur ✂

4 Etkinlik Ğ, ğ Sesi

5.

Etkinlik Ğ, ğ Sesi Boya, yaz.



ağaç

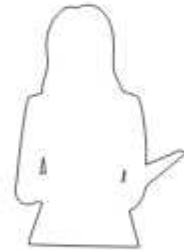
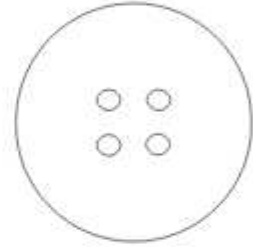

# 6.

Etkinlik Ğ, ğ Sesi Anlat, birleştir, yaz.



Çiğ dem düğ me dik.

Çiğdem düğme dik



Öğ len yağ mur yağ di.



U ğur da ğa tır man di.



Çağ la ha mur yo ğur du.



Mer ve ka ğıt kes ti.



Pa pa ğan a ğa ca kon du.



Etkinlik Ğ, ğ Sesi Oku, yaz.



## PIKNİK

Çağla ve ailesi köye pikniğe gitti. Annesi sepete soğan, domates, poğaçaya ve peynir koydu. Çağla köyde buğday tarlası gördü. Piknikte yağmur yağdı. Çağla ve ailesi bağ evine gitti. Bağ evinde sobayı yaktılar. Çağla çok eğlendi.

1. Çağla ve ailesi nereye gitti?

Pikniğe gitti.

2. Annesi sepete ne koydu?

|  |
|--|
|  |
|  |
|  |



Etkinlik

Ğ, ğ Sesi

Oku, yaz.

3. Çağla köyde ne gördü?

|  |
|--|
|  |
|  |
|  |

4. Bağ evinde ne yaktılar?

|  |
|--|
|  |
|  |
|  |

5. Metnin görselini çiz.

|  |
|--|
|  |
|--|





Etkinlik F, f Sesi Yaz.

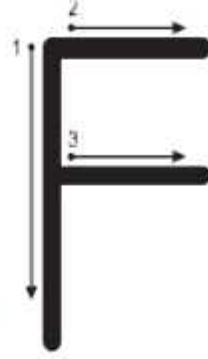

|    |    |    |    |    |    |    |    |    |    |    |    |    |
|----|----|----|----|----|----|----|----|----|----|----|----|----|
| FF | FF | FF | FF | FF | FF | FF | FF | FF | FF | FF | FF | FF |
|----|----|----|----|----|----|----|----|----|----|----|----|----|

|    |    |    |    |    |    |    |    |    |    |    |    |    |
|----|----|----|----|----|----|----|----|----|----|----|----|----|
| FF | FF | FF | FF | FF | FF | FF | FF | FF | FF | FF | FF | FF |
|----|----|----|----|----|----|----|----|----|----|----|----|----|

|    |    |    |    |    |    |    |    |    |    |    |    |    |
|----|----|----|----|----|----|----|----|----|----|----|----|----|
| FF | FF | FF | FF | FF | FF | FF | FF | FF | FF | FF | FF | FF |
|----|----|----|----|----|----|----|----|----|----|----|----|----|

|    |    |    |    |    |    |    |    |    |    |    |    |    |
|----|----|----|----|----|----|----|----|----|----|----|----|----|
| FF | FF | FF | FF | FF | FF | FF | FF | FF | FF | FF | FF | FF |
|----|----|----|----|----|----|----|----|----|----|----|----|----|

|    |    |    |    |    |    |    |    |    |    |    |    |    |
|----|----|----|----|----|----|----|----|----|----|----|----|----|
| FF | FF | FF | FF | FF | FF | FF | FF | FF | FF | FF | FF | FF |
|----|----|----|----|----|----|----|----|----|----|----|----|----|

|    |    |    |    |    |    |    |    |    |    |    |    |    |
|----|----|----|----|----|----|----|----|----|----|----|----|----|
| FF | FF | FF | FF | FF | FF | FF | FF | FF | FF | FF | FF | FF |
|----|----|----|----|----|----|----|----|----|----|----|----|----|

|    |    |    |    |    |    |    |    |    |    |    |    |    |
|----|----|----|----|----|----|----|----|----|----|----|----|----|
| FF | FF | FF | FF | FF | FF | FF | FF | FF | FF | FF | FF | FF |
|----|----|----|----|----|----|----|----|----|----|----|----|----|

|    |    |    |    |    |    |    |    |    |    |    |    |    |
|----|----|----|----|----|----|----|----|----|----|----|----|----|
| FF | FF | FF | FF | FF | FF | FF | FF | FF | FF | FF | FF | FF |
|----|----|----|----|----|----|----|----|----|----|----|----|----|

# 2.

## Etkinlik F, f Sesi Yaz.

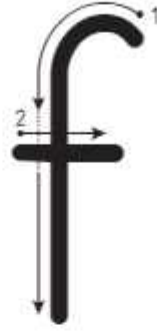

f f f f f f f f f f f f f f f

f f f f f f f f

f f f f f

f f f

f f

f

3

Etkinlik F, f Sesi

Kes, k p  yapıştır, anlat.

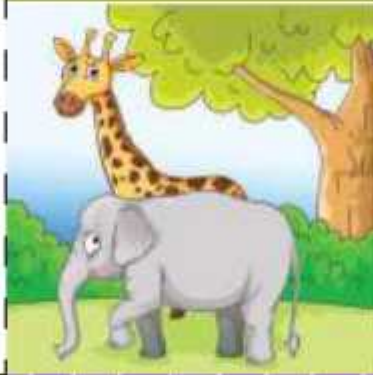



Etkinlik F, f Sesi

4

Etkinlik F, f Sesi

Kes, bul, yapıştır.

F

F

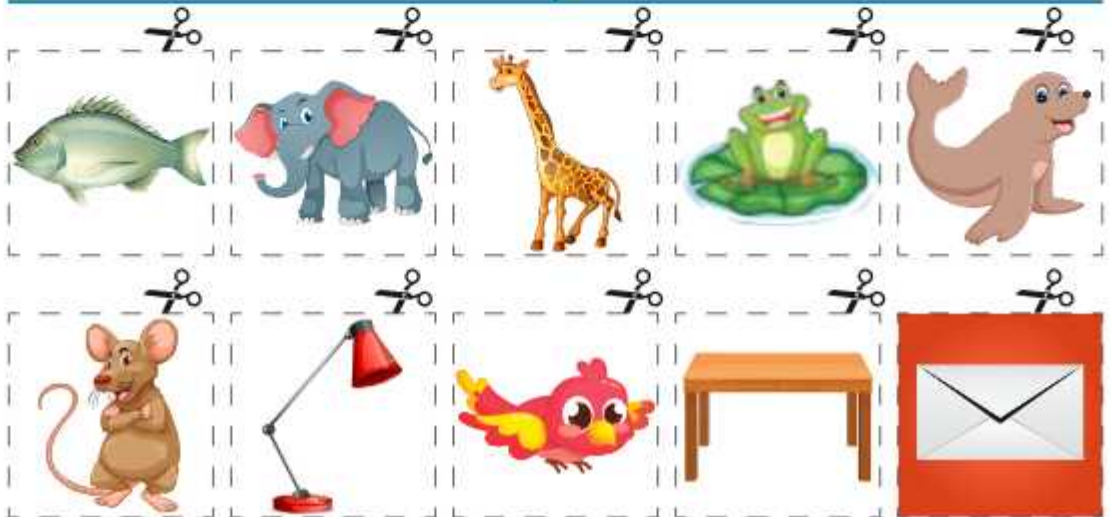



Etkinlik F, f Sesi

5

Etkinlik F, f Sesi

"F" yi bul, göle git.



|   |   |   |   |   |   |   |
|---|---|---|---|---|---|---|
| G | U | M | K | İ | T | F |
| A | H | N | D | L | F | E |
| Z | İ | R | B | F | O | H |
| İ | Ö | S | Ü | V | F | Y |
| Ş | E | R | T | F | B | C |
| Ö | Ç | D | F | E | Ğ | Z |
| G | B | F | C | L | S | Ü |
| R | P | T | F | B | A | İ |
| Ş | E | F | T | P | Ö | C |
| A | F | R | Ç | Ğ | A | Z |
| F | G | H | İ | K | B | M |

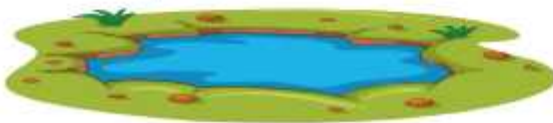

## 6.

## Etkinlik F, f Sesi

Bul, yaz.

a r e f



fare

i f l



d i k f i n



a f a k



t a l i ş e f



k o f



f e d r e t

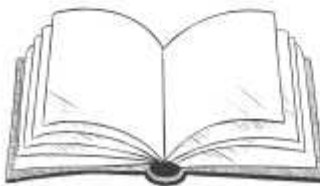

r a z ü f a







Etkinlik

F, f Sesi

Oku, yaz.

Kocaman bir yaşarmış.

fil



Fil yürüdükçe

ormanda



küçük korkarmış.



Fare arkasına saklanırmış



Küçük fare, minik fare,

Ne korkarsın filden?

Oysa çok sever görünce seni.



Etkinlik

J, j Sesi

Yaz.

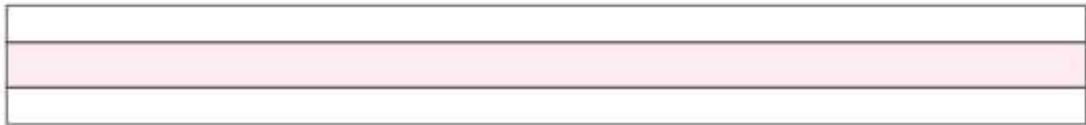
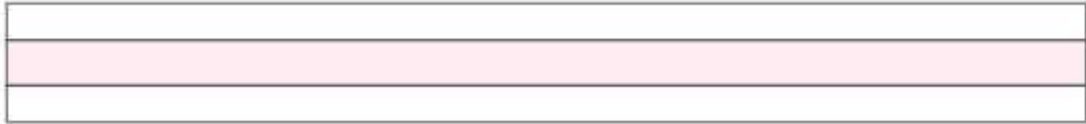
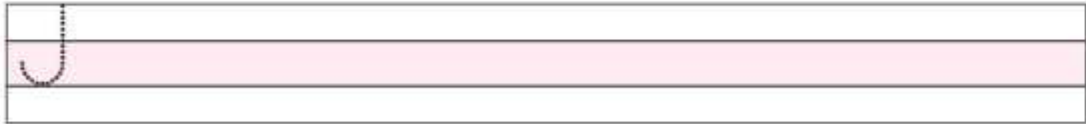
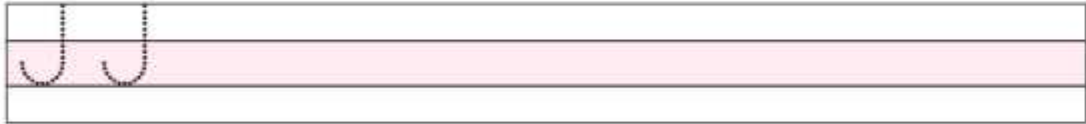
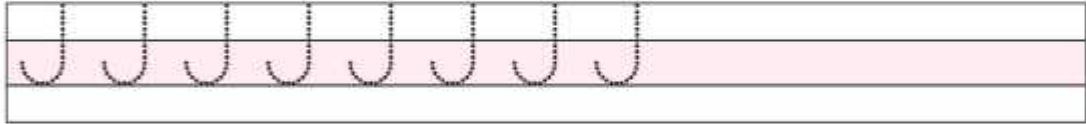
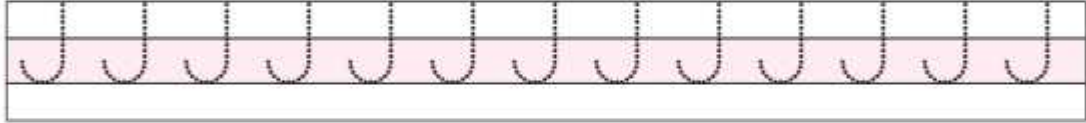

2.

Etkinlik J, j Sesi Yaz.



Handwriting practice lines for the letter 'J'. Each line consists of three horizontal bands: a top band, a middle band, and a bottom band. The first line contains 12 dotted uppercase 'J's for tracing. The second line contains 8 dotted uppercase 'J's. The third line contains 5 dotted uppercase 'J's. The fourth line contains 3 dotted uppercase 'J's. The fifth line contains 2 dotted uppercase 'J's. The sixth line contains 1 dotted uppercase 'J'. The remaining four lines are blank for independent practice.



Etkinlik J, j Sesi

Adında "j" sesi  
olanları boya.

hava ekmek vazo  
iğne uçak ev judo ağaç  
ilaç jüri pijama çiçek şapka kâğıt pul kapı şapka kâğıt  
su jeton hırka göz muz ajanda murat masa  
ayı cetvel baraj jilet araba elbise viraj abajur  
bahçe silgi sanem sevgi balık kütük ip el

4

Etkinlik

J, j Sesi

Boya, kes, yapıştır.



j



j

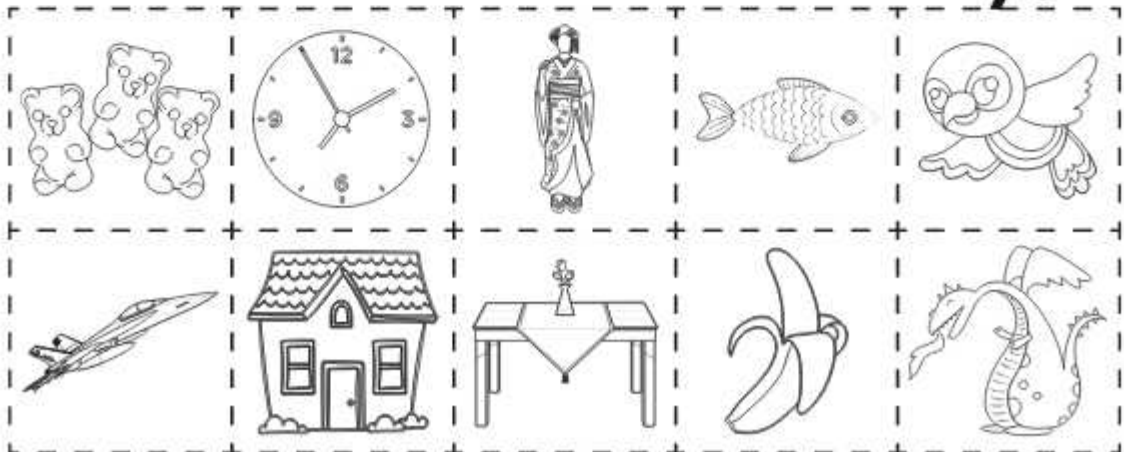

4 Etkinlik J, j Sesi

5

Etkinlik

J, j Sesi

Boya, yaz.

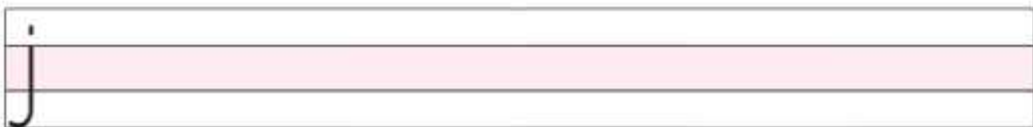
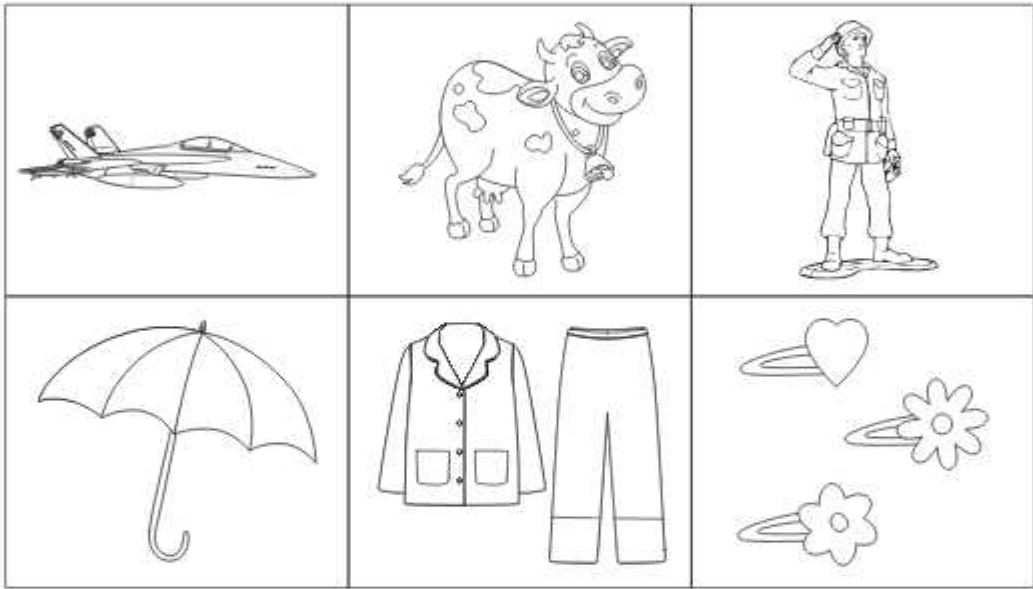

# 6.

## Etkinlik

### J, j Sesi

Oku, yaz.

Jale



Jale

jöle



bagaj



jet



jeton



judo



mesaj



Japon







Etkinlik

J, j Sesi

Oku, eşleştir.

Müjde, saçına jöle sürdü.



Jale ile Ajda jandarma gördü.



Mert judo yapıyor.



Jülide jimnastik yapar.





Etkinlik J, j Sesi Bak, adını yaz.



plaj



Blank lines for writing the name of the dragon.



Blank lines for writing the name of the razor blade.



Blank lines for writing the name of the police officer.



Blank lines for writing the name of the pajama set.



Blank lines for writing the name of the smartphone.

# 9

Etkinlik

J, j Sesi

Bak, adını yaz.

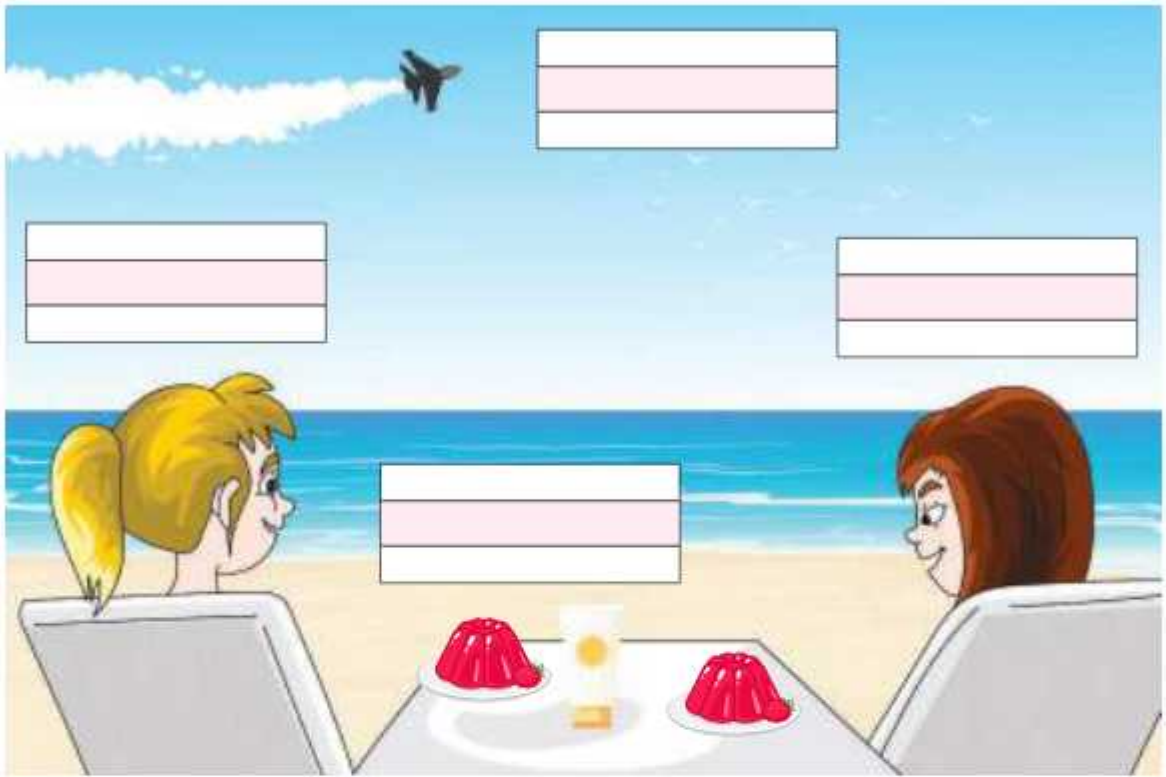

# 10

Etkinlik

J, j Sesi

Eşle, yaz.

Ne

raj

baraj



ba

le



Ja

jat





